



Title	<i>Reference Design Report for 2.75 W Non-Isolated Buck Converter Using LinkSwitch™ -TN2 LNK3207D</i>
Specification	85 VAC – 265 VAC Input; 5 V, 550 mA Output
Application	Home and Building Automation
Author	Applications Engineering Department
Document Number	RDR-721
Date	October 27, 2020
Revision	1.0

Summary and Features

- Highly integrated solution with LNK3207D
- Non-isolated 5 V / 550 mA output ($\pm 7\%$) for WiFi and relay power
- Compact solution 1" x 1" x 0.5"
- <40 mW no-load input power at 230 VAC
- 0 to 50 °C ambient temperature operation range
- Optimized for low audible noise performance
- 1 kV differential line surge protection
- Load short-circuit protection
- Over-temperature protection with hysteretic recovery

PATENT INFORMATION

The products and applications illustrated herein (including transformer construction and circuits external to the products) may be covered by one or more U.S. and foreign patents, or potentially by pending U.S. and foreign patent applications assigned to Power Integrations. A complete list of Power Integrations' patents may be found at www.power.com. Power Integrations grants its customers a license under certain patent rights as set forth at <https://www.power.com/company/intellectual-property-licensing/>.

Power Integrations

5245 Hellyer Avenue, San Jose, CA 95138 USA.
Tel: +1 408 414 9200 Fax: +1 408 414 9201
www.power.com

Table of Contents

1	Introduction	4
2	Power Supply Specification	5
3	Schematic	6
4	Circuit Description	7
4.1	Input EMI Filtering	7
4.2	LinkSwitch-TN2	7
4.3	Output Rectification	7
4.4	Output Feedback	7
5	PCB Layout	9
6	Bill of Materials	10
7	Epoxy Application	11
8	Design Spreadsheet.....	12
9	Performance Data	14
9.1	Efficiency vs. Line	14
9.2	Efficiency vs. Load	15
9.3	Average Efficiency	16
9.3.1	85 VAC / 60 Hz	16
9.3.2	115 VAC / 60 Hz	16
9.3.3	230 VAC / 50 Hz	16
9.3.4	265 VAC / 50 Hz	16
9.4	Standby Mode Efficiency	17
9.4.1	0.2 W Input Power.....	18
9.4.2	0.3 W Input Power.....	18
9.4.3	0.5 W Input Power.....	18
9.4.4	1.0 W Input Power.....	18
9.5	No-Load Input Power	19
9.6	Load Regulation	20
9.7	Line Regulation at Full Load	21
10	Thermal Performance.....	22
10.1	Ambient Thermal Performance	22
10.2	50 °C Thermal Performance	23
11	Waveforms.....	25
11.1	Switching Waveforms.....	25
11.1.1	LNK3207D V_{DS} and I_{DS} Waveforms Normal Operation	25
11.1.2	LNK3207D Drain Voltage and Current Waveforms During Start-Up	27
11.1.3	Drain Current and Output Waveform During Output Short	29
11.1.4	Freewheeling Diode Waveforms	30
11.1.5	Freewheeling Diode Waveforms During Startup	32
11.1.6	Output Voltage and Current Waveforms During Start-Up (CC Mode)	34
11.1.7	Output Voltage and Current Waveforms During Start-Up (CR Mode)	35
11.1.8	Output Voltage and Current Waveforms During Start-Up (Min Load)	36
11.2	Output Ripple Measurements.....	37
11.2.1	Ripple Measurement Set-up.....	37



11.2.2	Measurement Results	38
11.2.3	Ripple Voltage Waveforms	39
11.2.4	Transient Response.....	44
12	Conducted EMI	46
12.1	550 mA Resistive Load, Floating Output (QPK / AV)	46
12.1.1	115 VAC.....	46
12.1.2	230 VAC.....	47
13	Lighting Surge	48
13.1	Differential Mode Test.....	48
13.1.1	1000 V 90° Differential Mode Surge	48
14	Audible Noise.....	50
14.1	Test Set-up	50
14.2	115 VAC.....	51
14.3	230 VAC.....	52
15	Revision History	53

Important Note:

Although this board is designed to satisfy safety isolation requirements, the engineering prototype has not been agency approved. Therefore, all testing should be performed using an isolation transformer to provide the AC input to the prototype board.



1 Introduction

This document is an engineering prototype report describing a non-isolated 5 V, 550 mA power supply utilizing LNK3207D from Power Integrations. The board was designed to have a 1" x 1" PCB dimension and a 0.5" maximum component height. The document contains the power supply specification, schematic, bill-of-materials, printed circuit layout, and performance data.

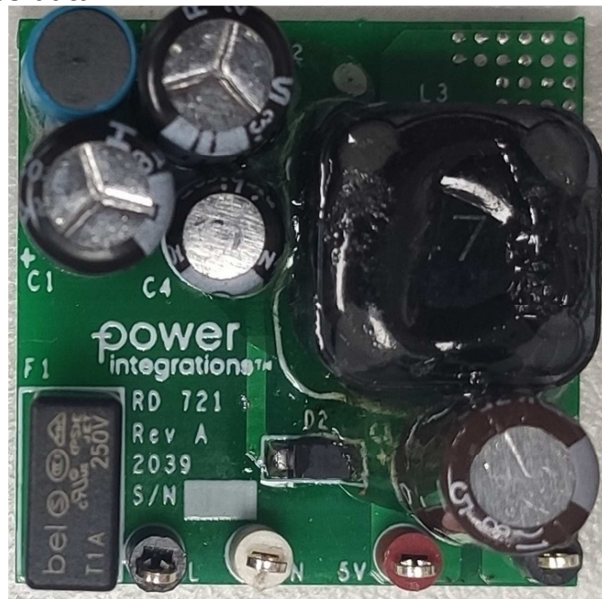

Figure 1– Populated Circuit Board Photograph, Top.

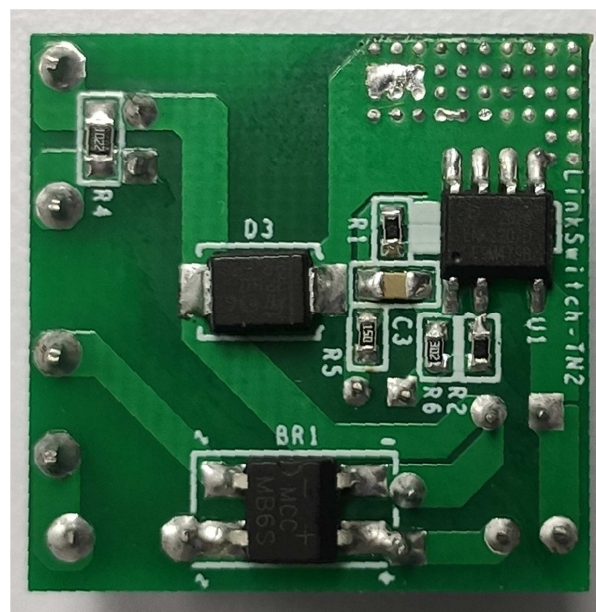

Figure 2 – Populated Circuit Board Photograph, Bottom.

2 Power Supply Specification

The table below represents the minimum acceptable performance of the design. Actual performance is listed in the results section.

Description	Symbol	Min	Typ	Max	Units	Comment	
Input							
Voltage	V_{IN}	85		265	VAC	2 Wire – no P.E.	
Frequency	f_{LINE}	47	50/60	64	Hz		
No-load Input Power (230 VAC)				<40	mW		
Output							
Output Voltage	V_{OUT}		5		V	±7%. 20 MHz Bandwidth.	
Output Ripple Voltage	V_{RIPPLE}			150	mV		
Output Current	I_{OUT}		550		mA	System Load upon Insertion	
Min. Output Current	$I_{OUT,MIN}$		27.5		mA		
Total Output Power							
Continuous Output Power	P_{OUT}		2.75		W		
Efficiency							
Full Load (Nominal)	η	66			%	Measured at the End of PCB. 25 °C.	
Ave Efficiency (Nominal)		68			%		
Environmental							
Conducted EMI		Meets CISPR22B / EN55022B					
Line Surge Differential Mode (L1-L2)			1		kV	1.2/50 μ s surge, IEC 61000-4-5, Series Impedance: Differential Mode: 2 Ω .	
Ambient Temperature	T_{AMB}	0		50	°C	Free Convection, Sea Level.	

3 Schematic

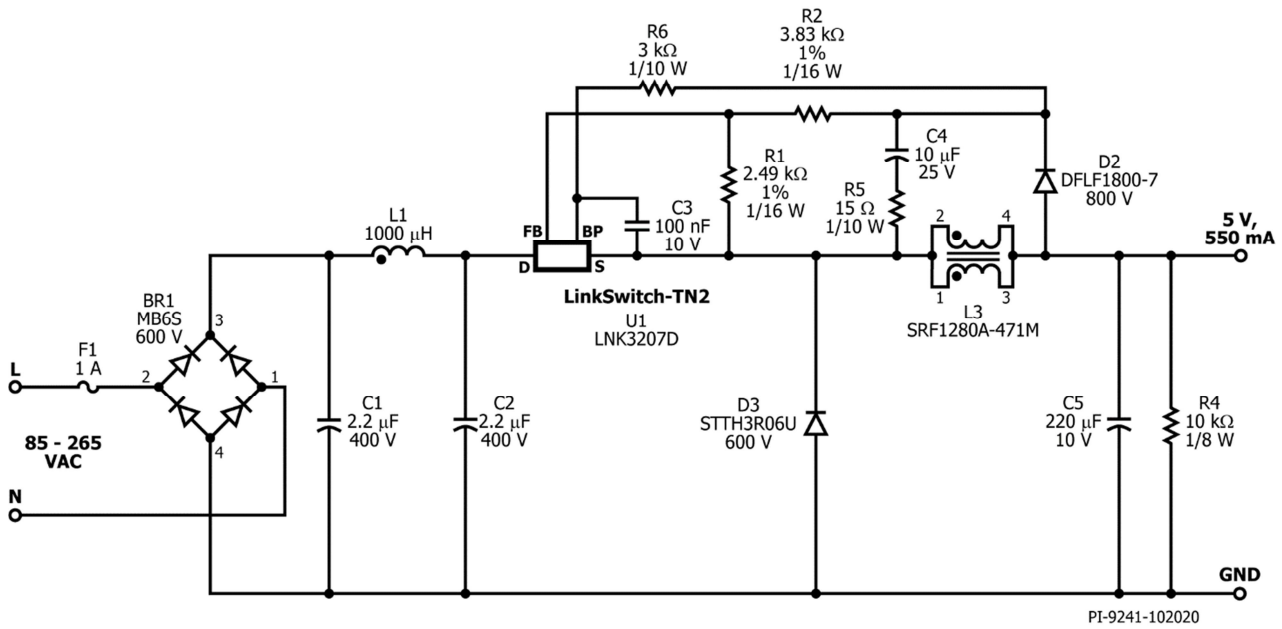

Figure 3 – Schematic.

4 Circuit Description

The schematic in Figure 3 shows an implementation of a buck converter using LNK3207D. The circuit provides a non-isolated 5 V, 550 mA continuous output.

4.1 *Input EMI Filtering*

The input stage is comprised of fuse F1, bridge diode BR1, and an EMI suppression circuit in a pi filter configuration with C1, inductor L1, and C2.

4.2 *LinkSwitch-TN2*

The LinkSwitch-TN2 combines a high-voltage power MOSFET and the power supply controller into a low cost monolithic IC.

When AC is first applied, an internal current source connected to the DRAIN (D) pin charges C3 to power the controller inside the IC. When the output voltage is established, the device controller will still be powered from the DRAIN pin during full load operation. The current limiting resistor R6, however, still minimizes losses when output voltage swings beyond 5 V during lighter load conditions.

LinkSwitch-TN2 family of controllers work on the principle of ON-OFF control in which output regulation is achieved by skipping cycles in response to a signal applied to the FEEDBACK (FB) pin. During full load operation, only a few switching cycles will be skipped (disabled), which results in a high effective switching frequency. As the load is reduced, some switching cycles are skipped reducing the effective switching frequency.

The LNK3207D IC mitigates audible noise by introducing another layer of control via a current limit state machine. The state machine functions by changing the current limit, at discrete intervals, with respect to the loading condition. This results to the LNK3207D IC operating at the maximum current limit at full load, and a lower current limit at lighter loads. The lower current limit not only reduces the inductor flux density but also raises the effective switching frequency above the audio range, consequently lowering the associated audible noise.

4.3 *Output Rectification*

When the internal MOSFET is on, current ramps through L3 until the internal current limit is reached. This then turns off the internal MOSFET and allows the inductor current to freewheel via diode D3 for the remainder of the switching cycle. For this design, an ultrafast diode (t_{RR} of 35 ns) is selected for D3 due to continuous operation at full load. Capacitor C5 should be selected to have an adequate ripple current rating (low ESR type).

4.4 *Output Feedback*

During the power MOSFET off-time, capacitor C4 is charged to the output voltage via D2. This voltage is used to provide feedback to the IC via the resistor divider formed by resistors R1 and R2. The FEEDBACK (FB) pin is then sampled by the controller inside U1

during each switching cycle. A current greater than 49 μA into the FB pin will inhibit the switching of the internal MOSFET while a current below will allow switching cycles to occur.

Due to the high difference between the input voltage and output voltage, the required average duty cycle for proper buck converter regulation becomes very low ($< \sim 5\%$ at 85 VAC and $< \sim 1.5\%$ at 265 VAC). Since control operation is on-off, minor delays in the feedback response may result to pulse bunching which could increase output ripple and produce audible noise from the magnetics. To mitigate this, an additional resistor, R5, is added in series with the sample-and-hold capacitor, C4. Resistor R5 adds more sensitivity to output perturbations and stabilizes the control loop which spreads the switching pulses more evenly, thus preventing pulse bunching.



5 PCB Layout

PCB material: FR4, Thickness: 1 mm, Copper: 2 oz. on both sides

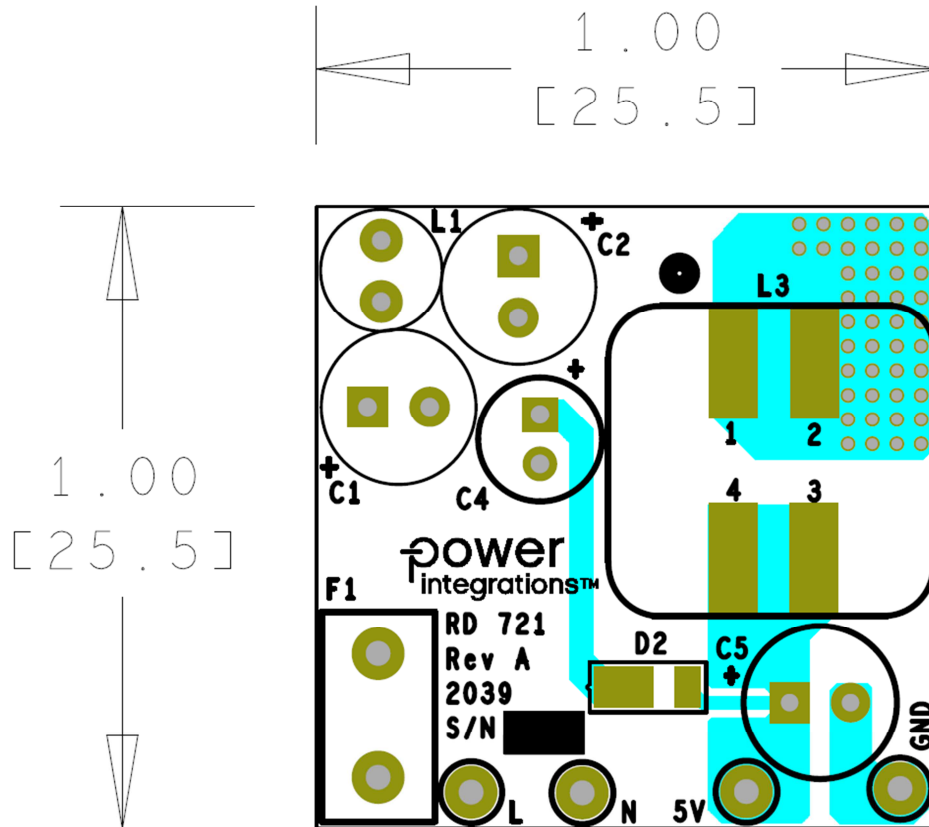

Figure 4 – Printed Circuit Layout, Top (1.0" [25.5 mm] L x 1.0" [25.5 mm] W).

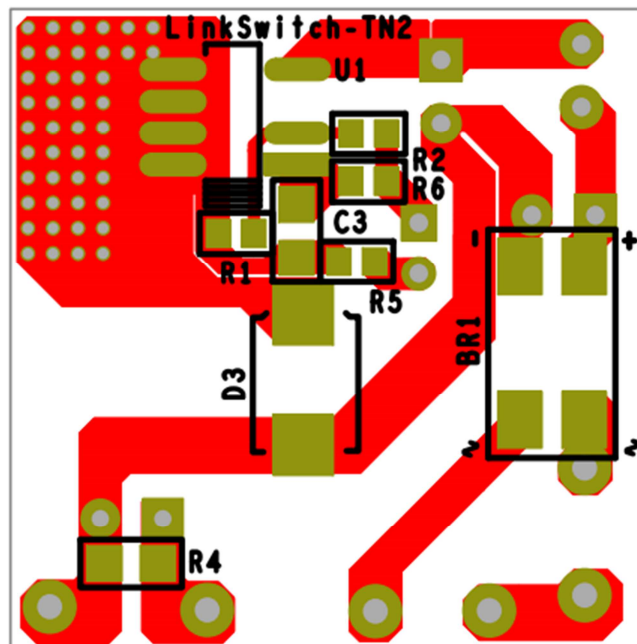

Figure 5 – Printed Circuit Layout, Bottom.



6 Bill of Materials

Item	Qty	Ref Des	Description	Mfg Part Number	Mfg
1	2	C1 C2	2.2 μ F, 400 V, Electrolytic, (6.3 x 9)	ERK2GM2R2E090T TAB2GM2R2E110	Aishi Ltec
2	1	C3	100 nF, 10 V, Ceramic, X7R, 0805	0805ZC104MAT2A	AVX
3	1	C4	10 μ F, 25 V, Electrolytic, Gen Purpose, (5 x 6)	UMT1E100MDD1TP	Nichicon
4	1	C5	220 μ F, 10 V, Electrolytic, Very Low ESR, 130 m Ω , (6.3 x 11.5)	EKZE100ELL221MF11D	Nippon Chemi-Con
5	1	BR1	600 V, 0.5 A, Bridge Rectifier, SMD, MBS-1, 4-SOIC	MB6S	Micro Commercial On Semi
6	1	D2	800V, 1 A, Fast Recovery Rectifier, POWERDI123	DFLF1800-7	Diodes
7	1	D3	600 V, 3 A, SMB, DO-214AA	STTH3R06U	ST Micro
8	1	L1	1000 μ H, 0.21 A, 5.5 x 10.55 mm	SBC1-102-211	Tokin Kemet
9	1	L3	Shielded 2 Coil Array, 470 μ H, 850 mA	SRF1280A-471M	Bourns
10	1	R1	RES, 2.49 k Ω , 1%, 1/16 W, Thick Film, 0603	ERJ-3EKF2491V	Panasonic
11	1	R2	RES, 3.83 k Ω , 1%, 1/16 W, Thick Film, 0603	ERJ-3EKF3831V	Panasonic
12	1	R4	RES, 10 k Ω , 5%, 1/8 W, Thick Film, 0805	ERJ-6GEYJ103V	Panasonic
13	1	R5	RES, 15 Ω , 5%, 1/10 W, Thick Film, 0603	ERJ-3GEYJ150V	Panasonic
14	1	R6	RES, 3 k Ω , 5%, 1/10 W, Thick Film, 0603	ERJ-3GEYJ302V	Panasonic
15	1	F1	1 A, 250 V, Slow, Long Time Lag, RST 1	RST 1	Belfuse
16	1	U1	LinkSwitch-TN2, SO-8C	LNK3207D	Power Integrations

Miscellaneous Parts

Item	Qty	Ref Des	Description	Mfg Part Number	Mfg
1	2	L, GND	Test Point, BLK, Miniature THRU-HOLE MOUNT	5001	Keystone
2	1	N	Test Point, WHT, Miniature THRU-HOLE MOUNT	5002	Keystone
3	1	5V	Test Point, RED, Miniature THRU-HOLE MOUNT	5000	Keystone
4	1	GLUE	Devcon's 5 Minute® Epoxy Stock #14270	14270	ITW Devcon



7 Epoxy Application

Epoxy is used on specific locations to minimize audible noise. Devcon's 5 Minute® Epoxy Stock #14270 or any equivalent can be used for this application. See figure below.

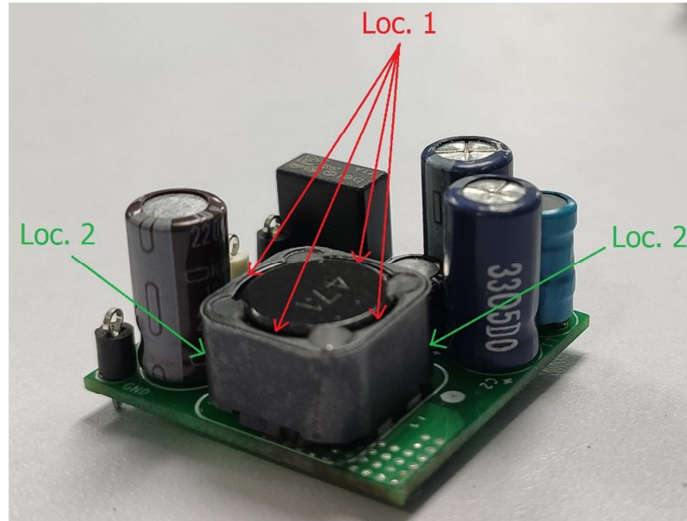

Figure 6 – Printed Circuit Layout, Bottom.

The main noise generator for this application is usually the Buck Choke, L3. Epoxy on location 1 acts as a sealant and prevents the noise generated by the shielded drum core to be apparent to the user. To secure and minimize further vibrations, epoxy on location 2 is applied between the choke, adjacent capacitor, and PCB.

8 Design Spreadsheet

ACDC_LinkSwitchTN2-Buck_052120; Rev.1.3; Copyright Power Integrations 2020	INPUT	INFO	OUTPUT	UNIT	ACDC_LinkSwitchTN2 Buck
APPLICATION VARIABLES					
LINE VOLTAGE RANGE			Universal		AC line voltage range
VACMIN			85.00	V	Minimum AC line voltage
VACTYP			115.00	V	Typical AC line voltage
VACMAX			265.00	V	Maximum AC line voltage
fL			60.00	Hz	AC mains frequency
LINE RECTIFICATION TYPE	F		F		Select 'F'ull wave rectification or 'H'alf wave rectification
VOUT	5.00		5.00	V	Output voltage
IOUT	0.550	Info	0.550	A	Device operation is too continuous, verify power delivery on the bench or select a larger device
EFFICIENCY_ESTIMATED	0.65		0.65		Efficiency estimate at output terminals
EFFICIENCY_CALCULATED			0.59		Calculated efficiency based on real components and operating point
POUT			2.75	W	Continuous Output Power
CIN	4.40		4.40	uF	Input capacitor
VMIN			61.8	V	Valley of the rectified input voltage
VMAX			374.8	V	Peak of the rectified maximum input AC voltage
T_AMBIENT			50	degC	Operating ambient temperature in degrees celcius
INPUT STAGE RESISTANCE			10	Ohms	Input stage resistance in ohms (includes fuse, thermistor, filtering components)
PLOSS_INPUTSTAGE			0.025	W	Input stage losses estimate
LINKSWITCH-TN2 VARIABLES					
OPERATION MODE			MCM		Mostly continuous mode of operation
CURRENT LIMIT MODE	STD		STD		Choose 'RED' for reduced current limit or 'STD' for standard current limit
PACKAGE	SO-8C		SO-8C		Select the device package
DEVICE SERIES	Auto		LNK32X7		Generic LinkSwitch-TN2 device
DEVICE CODE			LNK3207		Required LinkSwitch-TN2 device
ILIMITMIN			0.725	A	Minimum current limit of the device
ILIMITTYP			0.780	A	Typical current limit of the device
ILIMITMAX			0.835	A	Maximum current limit of the device
RDSON			12.90	ohms	MOSFET's on-time drain to source resistance at 100degC
FSMIN			62000	Hz	Minimum switching frequency
FSTYP			66000	Hz	Typical switching frequency
FSMAX			70000	Hz	Maximum switching frequency
VDSON			2.00	V	MOSFET on-time drain to source voltage estimate
DUTY			0.09		Maximum duty cycle
TIME_ON			1.520	us	MOSFET conduction time at the minimum line voltage
TIME_ON_MIN			0.993	us	MOSFET conduction time at the maximum line voltage
KP_TRANSIENT		Info	0.069		Transient KP less than 0.2 may lead to a leading edge SOA trigger
IRMS_MOSFET			0.172	A	MOSFET RMS current
PLOSS_MOSFET			0.732	W	Primary MOSFET loss estimate
BUCK INDUCTOR PARAMETERS					
INDUCTANCE_MIN			423	uH	Minimum design inductance required for power delivery
INDUCTANCE_TYP	470		470	uH	Typical design inductance required for power delivery
INDUCTANCE_MAX			517	uH	Maximum design inductance required for power delivery
TOLERANCE_INDUCTANCE			10	%	Tolerance of the design inductance
DC RESISTANCE OF			2.0	ohms	DC resistance of the buck inductor



INDUCTOR					
FACTOR_LOSS			0.825		Factor that accounts for "off-state" power loss to be supplied by inductor
IRMS_INDUCTOR			0.559	A	Inductor RMS current
PLOSS_INDUCTOR			0.625	W	Inductor losses
FREEWHEELING DIODE PARAMETERS					
VF_FREEWHEELING			0.70	V	Forward voltage drop of the freewheeling diode
PIV			468	V	Peak inverse voltage of the freewheeling diode
IRMS_DIODE			0.532	A	Diode RMS current
TRR			30	ns	Required reverse recovery time of the selected diode
PLOSS_DIODE			0.547	W	Freewheeling diode losses
RECOMMENDED DIODE			BYV26C	W	Recommended freewheeling diode
BIAS/FEEDBACK PARAMETERS					
VF_BIAS			0.70	V	Forward voltage drop of the bias diode
RBIAS			2490	Ohms	Bias resistor
CBP			0.1	uF	BP pin capacitor
RFB			3480	Ohms	Feedback resistor
CFB			10	uF	Feedback capacitor
C_SOFTSTART				uF	No soft-start capacitor required
PLOSS_FEEDBACK			0.004	W	Feedback section losses
OUTPUT CAPACITOR					
OUTPUT VOLTAGE RIPPLE			100	mV	Desired output voltage ripple
IRIPPLE_COUT			0.350	A	Output capacitor ripple current
ESR_COUT			286	mOhms	Maximum ESR of the output capacitor

9 Performance Data

All measurements performed at room temperature.

9.1 Efficiency vs. Line

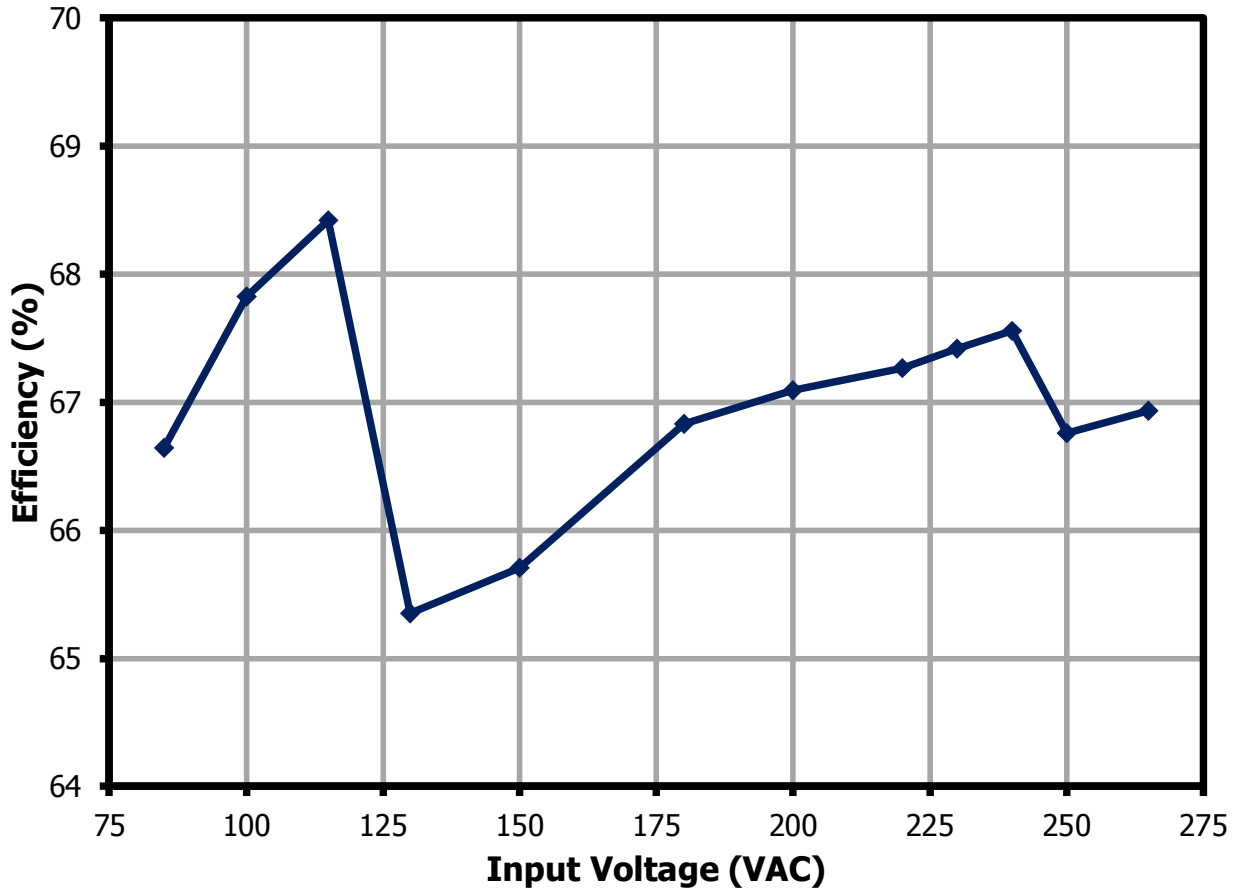

Figure 7 – Full Load (550 mA) Efficiency vs. Line Voltage, Room Temperature.

9.2 **Efficiency vs. Load**

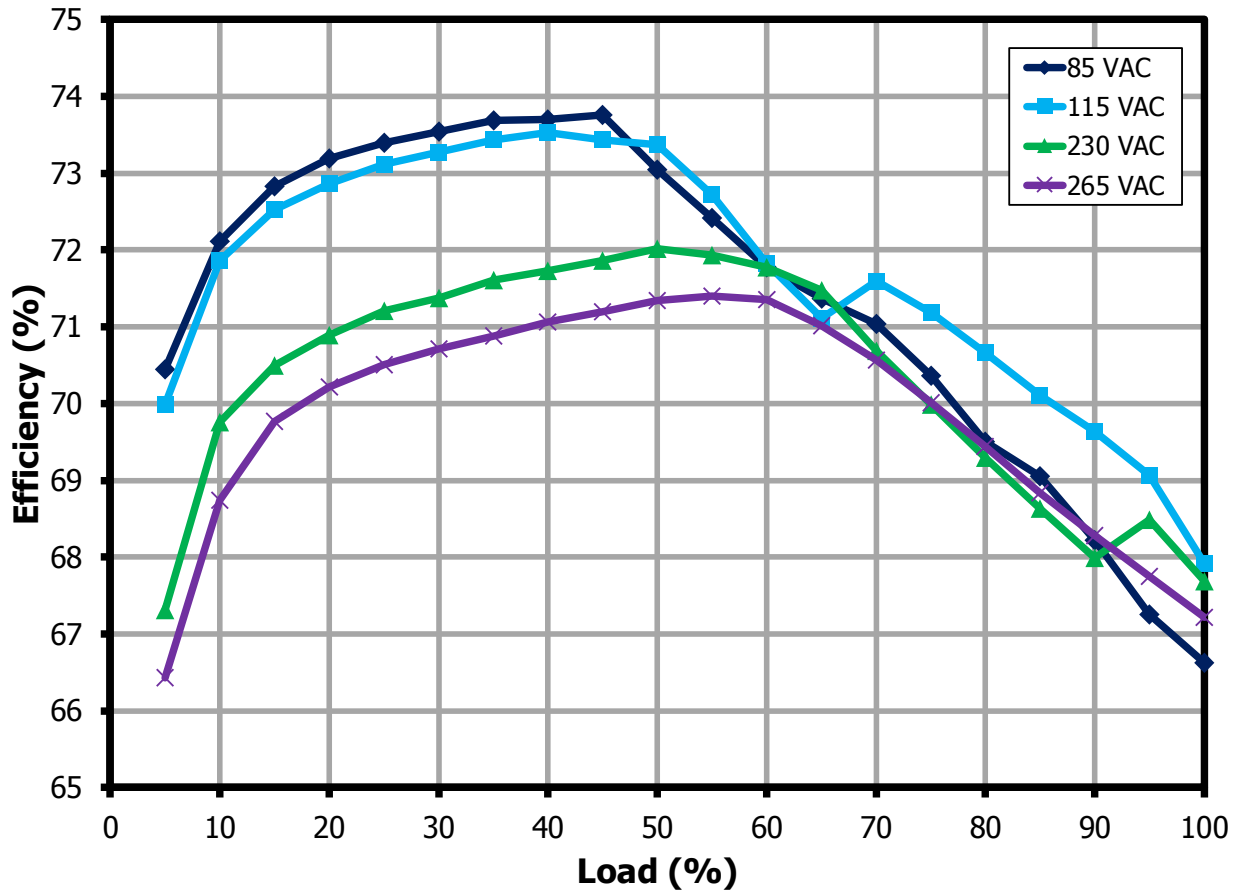

Figure 8 – Efficiency vs. Load, Room Temperature.



9.3 Average Efficiency

9.3.1 85 VAC / 60 Hz

Load (A)	V _{IN} (V _{RMS})	I _{IN} (mA _{RMS})	P _{IN} (W)	V _{OUT} at PCB (V _{DC})	I _{OUT} (mA _{DC})	P _{OUT} (W)	Efficiency at PCB (%)
100%	85	81.91	4.04	4.90	550.31	2.69	66.62
75%	85	60.20	2.80	4.92	412.86	2.03	70.36
50%	85	42.16	1.87	4.95	275.42	1.36	73.05
25%	85	25.32	0.94	5.01	137.79	0.69	73.4
						Average	70.86

9.3.2 115 VAC / 60 Hz

Load (A)	V _{IN} (V _{RMS})	I _{IN} (mA _{RMS})	P _{IN} (W)	V _{OUT} at PCB (V _{DC})	I _{OUT} (mA _{DC})	P _{OUT} (W)	Efficiency at PCB (%)
100%	115	62.17	3.96	4.89	550.27	2.69	67.92
75%	115	47.75	2.85	4.92	412.81	2.03	71.19
50%	115	34.35	1.86	4.95	275.37	1.36	73.37
25%	115	20.92	0.94	5.00	137.92	0.69	73.11
						Average	71.40

9.3.3 230 VAC / 50 Hz

Load (A)	V _{IN} (V _{RMS})	I _{IN} (mA _{RMS})	P _{IN} (W)	V _{OUT} at PCB (V _{DC})	I _{OUT} (mA _{DC})	P _{OUT} (W)	Efficiency at PCB (%)
100%	230	38.80	3.98	4.89	550.25	2.69	67.69
75%	230	30.53	2.90	4.92	412.80	2.03	69.98
50%	230	22.04	1.89	4.94	275.37	1.36	72.01
25%	230	13.39	0.97	4.98	137.90	0.69	71.21
						Average	70.22

9.3.4 265 VAC / 50 Hz

Load (A)	V _{IN} (V _{RMS})	I _{IN} (mA _{RMS})	P _{IN} (W)	V _{OUT} at PCB (V _{DC})	I _{OUT} (mA _{DC})	P _{OUT} (W)	Efficiency at PCB (%)
100%	265	35.89	4.00	4.89	550.24	2.69	67.22
75%	265	27.92	2.9	4.91	412.78	2.03	70.01
50%	265	20.39	1.90	4.93	275.33	1.36	71.35
25%	265	12.23	0.97	4.98	137.88	0.69	70.50
						Average	69.77

9.4 **Standby Mode Efficiency**

Test Condition: Soak at full load for 5 minutes and decrease load to standby mode for 5 minutes for each line step.

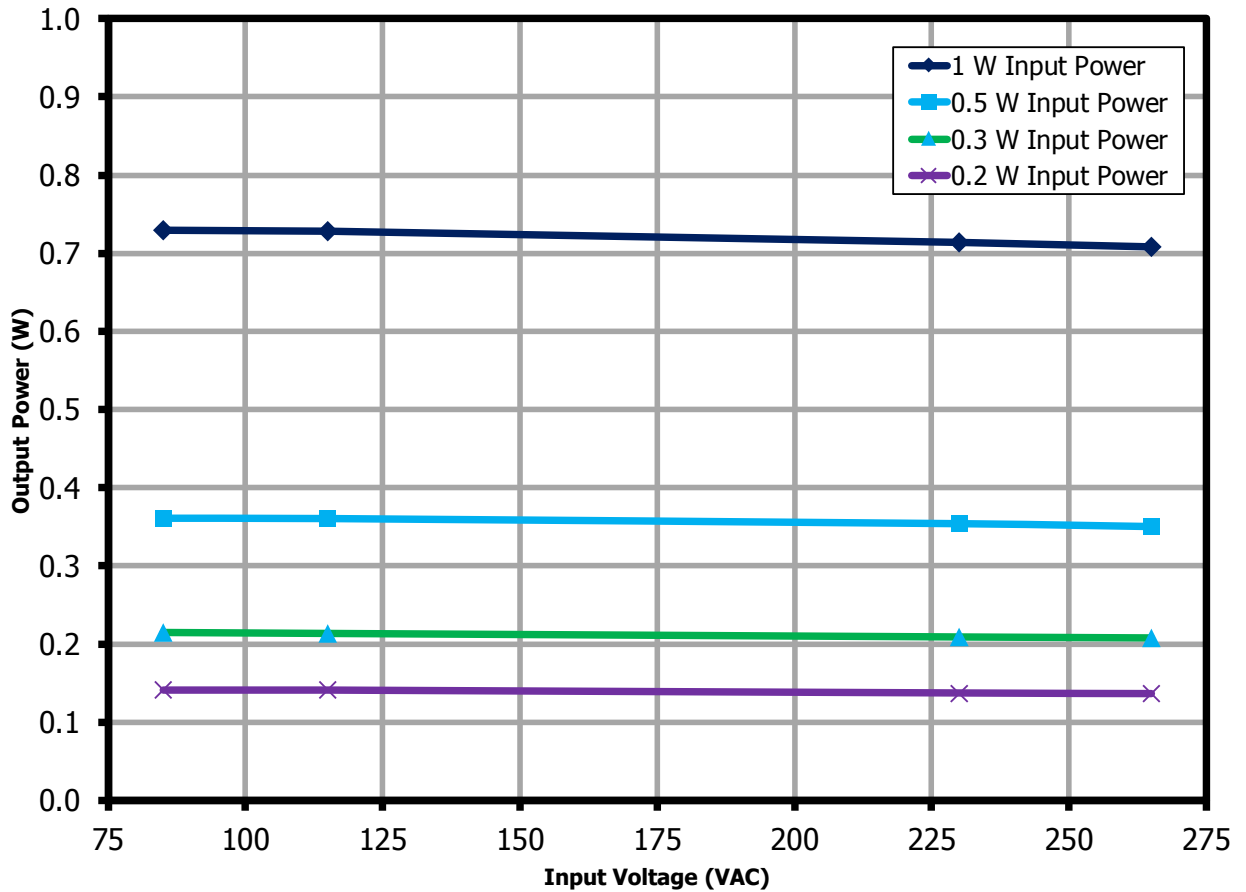

Figure 9 – Available Output Power vs. Input Power.



9.4.1 0.2 W Input Power

Input Measurement			Output 1 Measurement			Efficiency (%)
V _{IN} (RMS)	I _{IN} (mA)	P _{IN} (W)	V _{OUT} (V)	I _{OUT} (mA)	P _{OUT} (W)	
85	8.524	0.2	5.219	26.975	0.141	70.5
115	7.105	0.2	5.226	26.879	0.141	70.5
230	4.237	0.2	5.265	26.060	0.137	68.5
265	3.701	0.2	5.284	25.674	0.136	68.0

9.4.2 0.3 W Input Power

Input Measurement			Output 1 Measurement			Efficiency (%)
V _{IN} (RMS)	I _{IN} (mA)	P _{IN} (W)	V _{OUT} (V)	I _{OUT} (mA)	P _{OUT} (W)	
85	11.148	0.3	5.127	41.840	0.2145	71.5
115	9.192	0.3	5.127	41.729	0.2139	71.3
230	5.659	0.3	5.145	40.800	0.2093	69.8
265	4.963	0.3	5.153	40.314	0.2078	69.3

9.4.3 0.5 W Input Power

Input Measurement			Output 1 Measurement			Efficiency (%)
V _{IN} (RMS)	I _{IN} (mA)	P _{IN} (W)	V _{OUT} (V)	I _{OUT} (mA)	P _{OUT} (W)	
85	15.580	0.5	5.044	71.65	0.3614	72.3
115	12.942	0.5	5.040	71.56	0.3607	72.1
230	8.313	0.5	5.041	70.24	0.3541	70.8
265	7.397	0.5	5.040	69.57	0.3506	70.1

9.4.4 1.0 W Input Power

Input Measurement			Output 1 Measurement			Efficiency (%)
V _{IN} (RMS)	I _{IN} (mA)	P _{IN} (W)	V _{OUT} (V)	I _{OUT} (mA)	P _{OUT} (W)	
85	25.282	1	4.969	146.81	0.7295	73.0
115	21.112	1	4.964	146.71	0.7281	72.8
230	13.937	1	4.951	144.14	0.7136	71.4
265	12.754	1	4.948	143.21	0.7086	70.9

9.5 **No-Load Input Power**

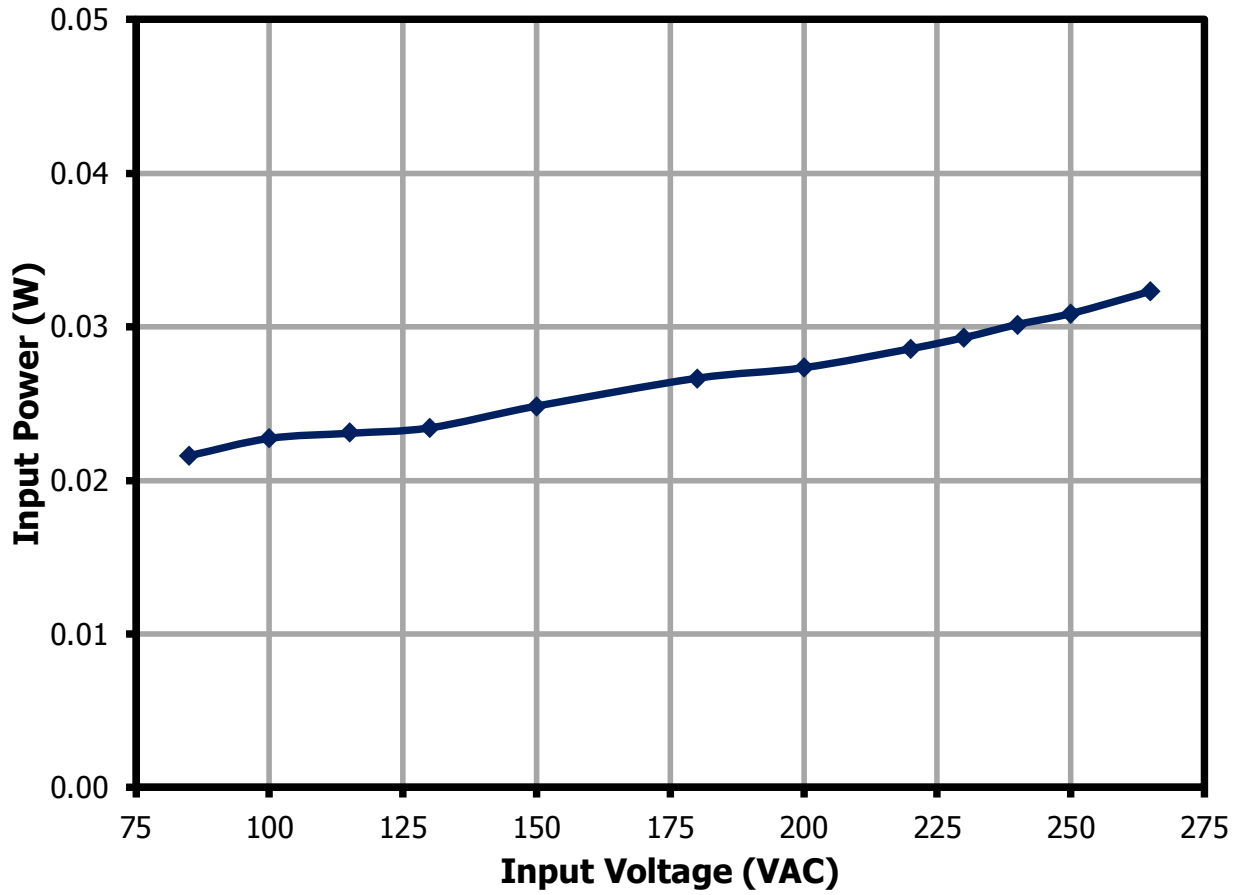

Figure 10 – No-Load Input Power vs. Input Line Voltage, Room Temperature.



9.6 Load Regulation

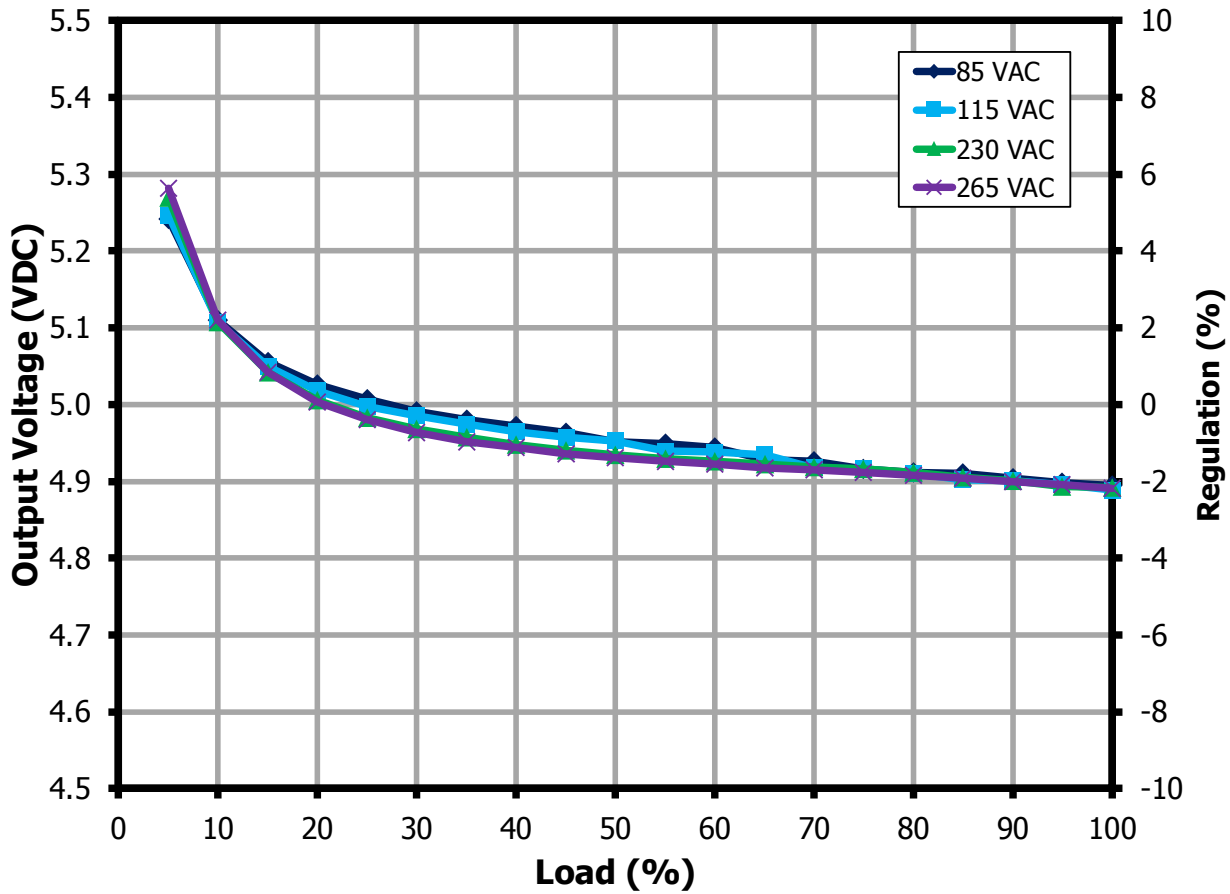

Figure 11 – Output Voltage vs. Output Current, Room Temperature.

9.7 *Line Regulation at Full Load*

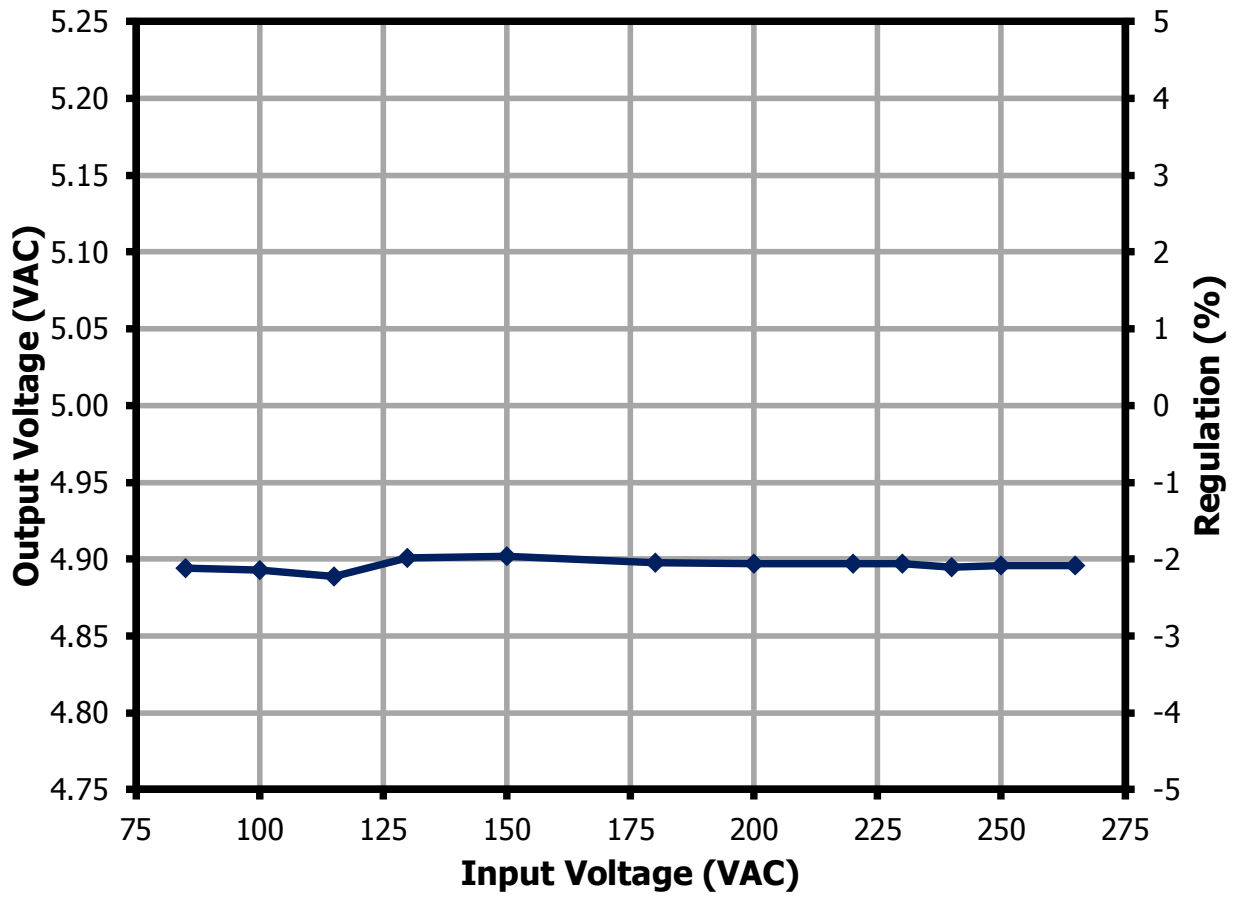

Figure 12 – Output Voltage vs. Input Voltage, Room Temperature.



10 Thermal Performance

10.1 Ambient Thermal Performance

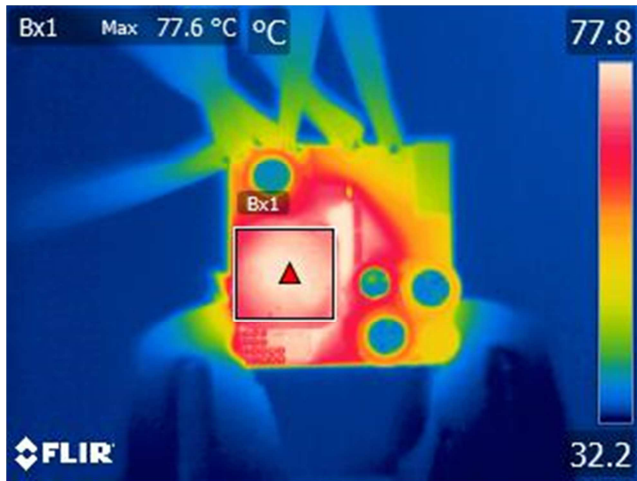

Figure 13 – Buck Choke (Bx1), 77.6 °C.
85 VAC, 550mA Output.

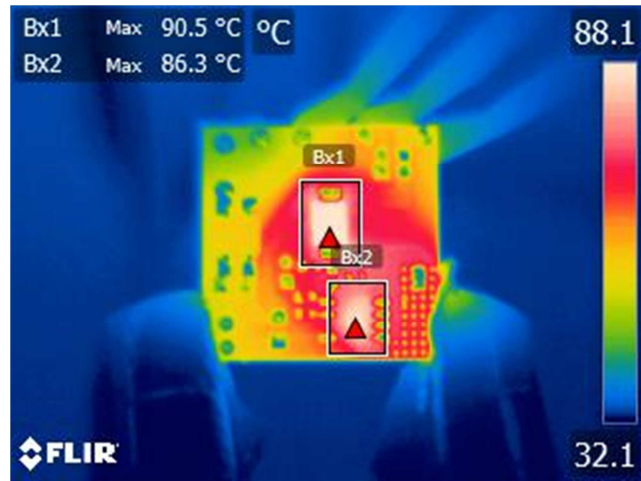

Figure 14 – Buck Diode (Bx1), 90.5 °C.
LNK3207D (Bx2), 86.3 °C.
85 VAC, 550mA Output.

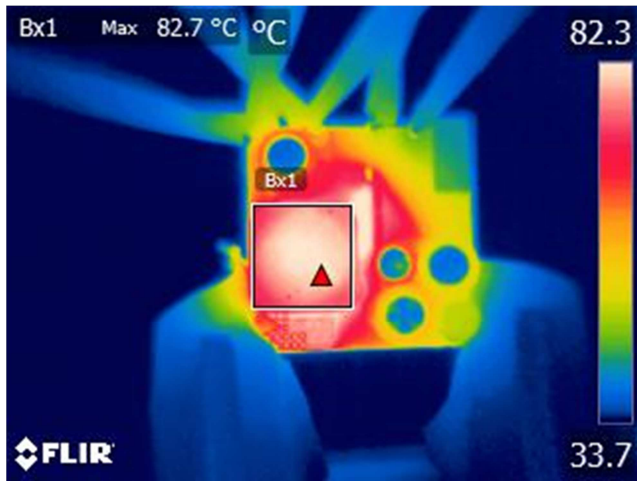

Figure 15 – Buck Choke (Bx1), 82.7 °C.
265 VAC, 550 mA Output.

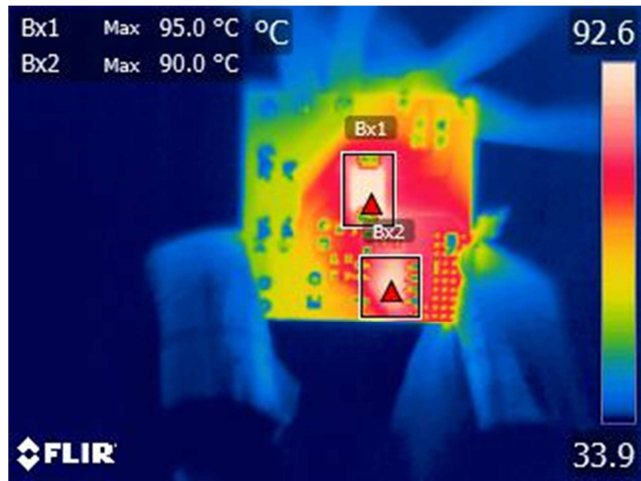

Figure 16 – Buck Diode (Bx1), 95.0 °C.
LNK3207D (Bx2), 90.0 °C.
265 VAC, 550 mA Output.

10.2 **50 °C Thermal Performance**

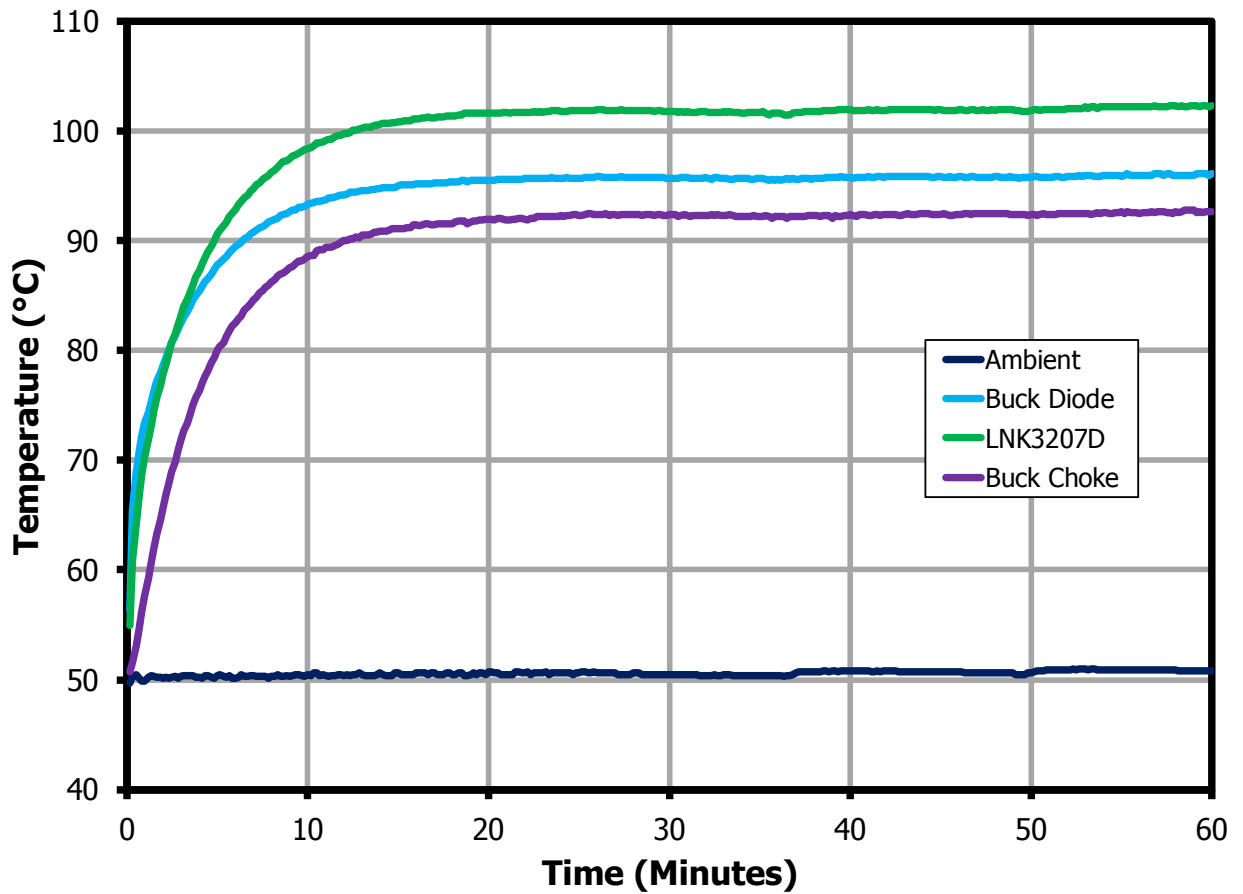

Figure 17 – 85 VAC Thermal Performance at Full Load.

Component	Temperature (°C)
Buck Choke, L3	92.6
Buck Diode, D3	95.9
LNK3207D, U1	102.1
Ambient	50.7



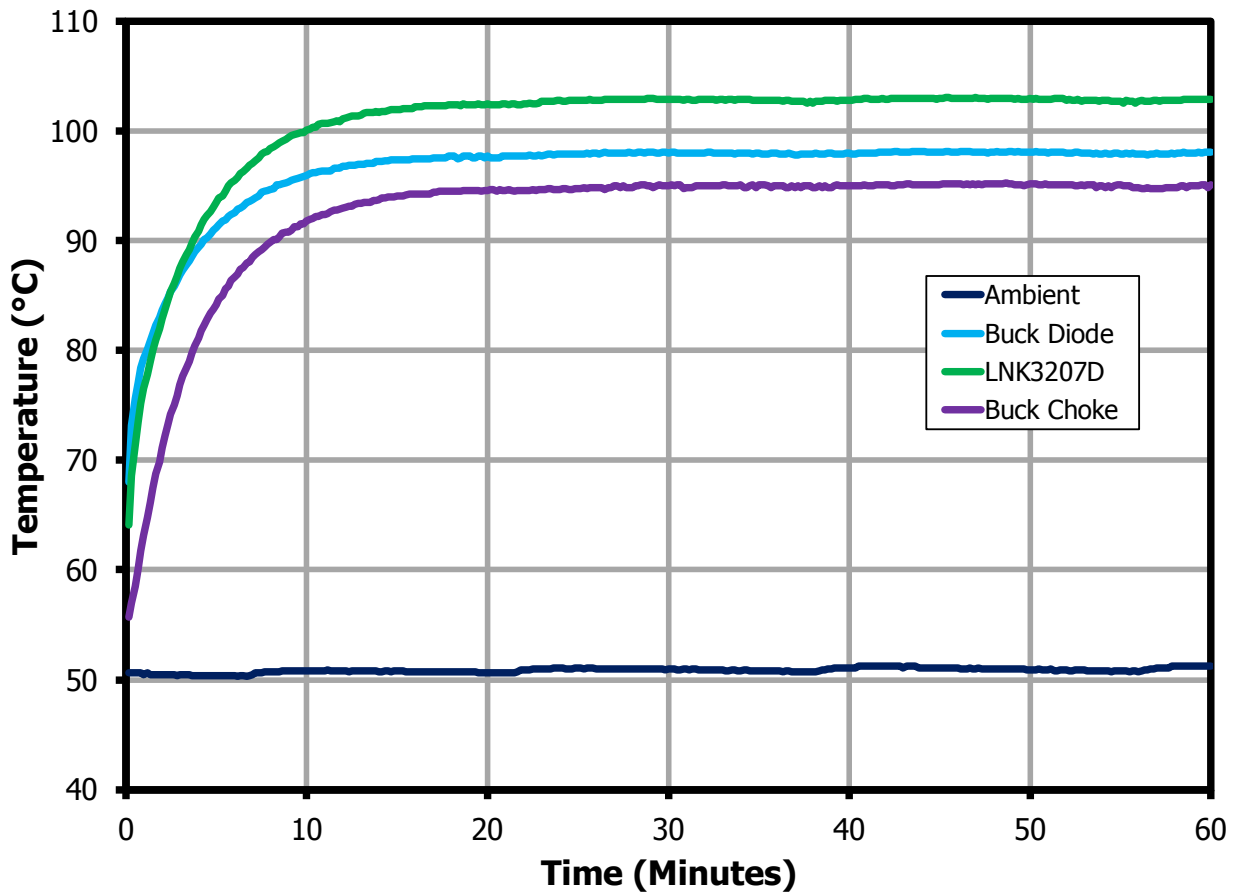

Figure 18 – 265 VAC Thermal Performance at Full Load.

Component	Temperature (°C)
Buck Choke, L3	95.1
Buck Diode, D3	98.1
LNK3207D, U1	102.9
Ambient	51.2

11 Waveforms

11.1 Switching Waveforms

11.1.1 LNK3207D V_{DS} and I_{DS} Waveforms Normal Operation

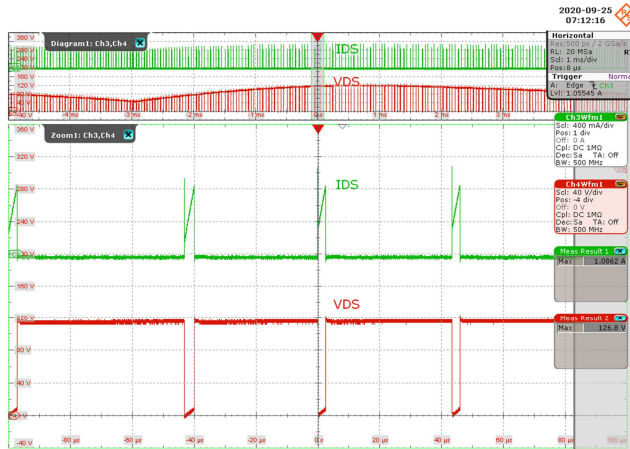

Figure 19 – Drain Voltage and Current Waveforms. 85 VAC, 550 mA Output. Upper: I_{DS} , 400 mA / div. Lower: V_{DS} , 40 V / div., 20 μ s / div. $I_{DS(MAX)} = 1.09$ A, $V_{DS(MAX)} = 126.8$ V.



Figure 20 – Drain Voltage and Current Waveforms. 115 VAC, 550 mA Output. Upper: I_{DS} , 400 mA / div. Lower: V_{DS} , 40 V / div., 20 μ s / div. $I_{DS(MAX)} = 1.17$ A, $V_{DS(MAX)} = 174.2$ V.

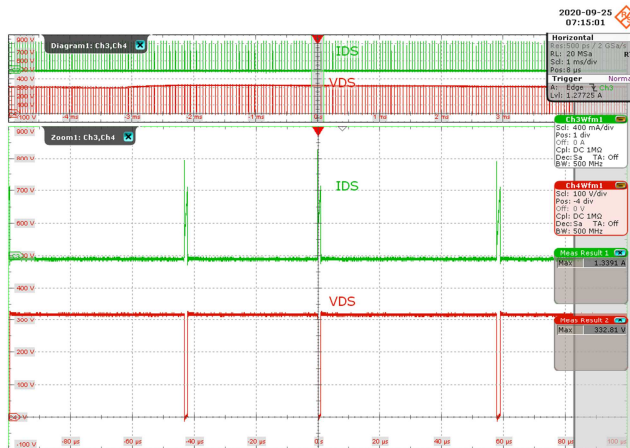

Figure 21 – Drain Voltage and Current Waveforms. 230 VAC, 550 mA Output. Upper: I_{DS} , 400 mA / div. Lower: V_{DS} , 100 V / div., 20 μ s / div. $I_{DS(MAX)} = 1.34$ A, $V_{DS(MAX)} = 332.8$ V.



Figure 22 – Drain Voltage and Current Waveforms. 265 VAC, 550 mA Output. Upper: I_{DS} , 400 mA / div. Lower: V_{DS} , 100 V / div., 20 μ s / div. $I_{DS(MAX)} = 1.37$ A, $V_{DS(MAX)} = 384.2$ V.



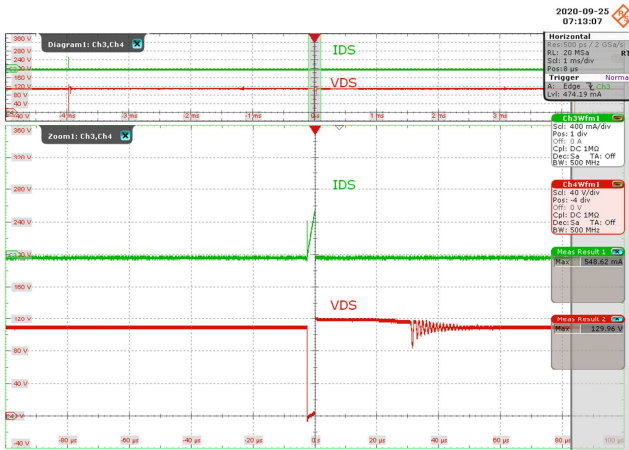

Figure 23 – Drain Voltage and Current Waveforms.
 85 VAC, 0 mA Output.
 Upper: I_{DS} , 400 mA / div.
 Lower: V_{DS} , 40 V / div., 20 μ s / div.
 $I_{DS(MAX)} = 549$ mA, $V_{DS(MAX)} = 130.0$ V.

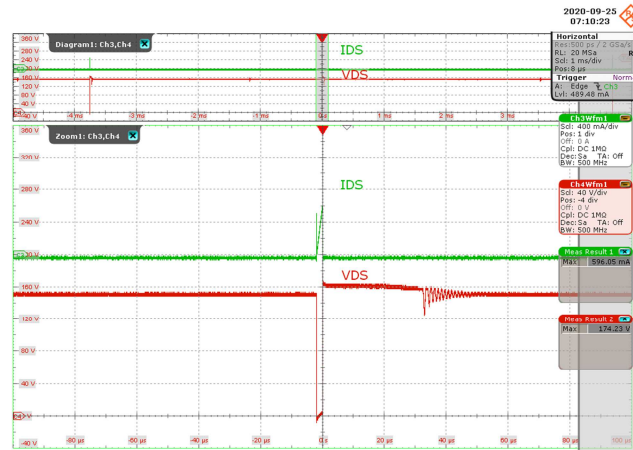

Figure 24 – Drain Voltage and Current Waveforms.
 115 VAC, 0 mA Output.
 Upper: I_{DS} , 400 mA / div.
 Lower: V_{DS} , 40 V / div., 20 μ s / div.
 $I_{DS(MAX)} = 596$ mA, $V_{DS(MAX)} = 174.2$ V.

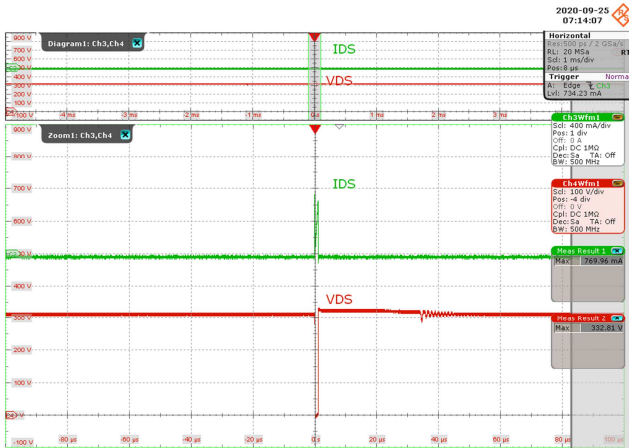

Figure 25 – Drain Voltage and Current Waveforms.
 230 VAC, 0 mA Output.
 Upper: I_{DS} , 400 mA / div.
 Lower: V_{DS} , 100 V / div., 20 μ s / div.
 $I_{DS(MAX)} = 770$ mA, $V_{DS(MAX)} = 332.8$ V.

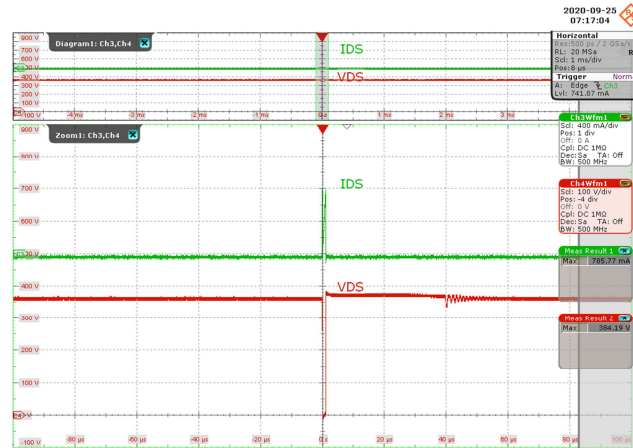

Figure 26 – Drain Voltage and Current Waveforms.
 265 VAC, 0 mA Output.
 Upper: I_{DS} , 400 mA / div.
 Lower: V_{DS} , 100 V / div., 20 μ s / div.
 $I_{DS(MAX)} = 786$ mA, $V_{DS(MAX)} = 384.2$ V.

11.1.2 LNK3207D Drain Voltage and Current Waveforms During Start-Up

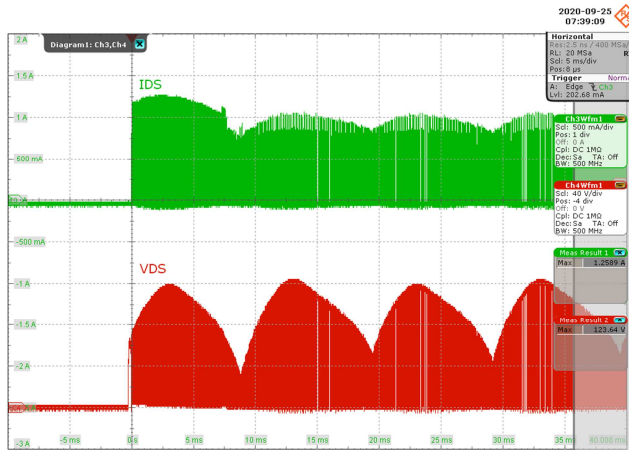

Figure 27 – Drain Voltage and Current Waveforms.
 85 VAC, 550 mA Output.
 Upper: I_{DS} , 500 mA / div.
 Lower: V_{DS} , 40 V / div., 5 ms / div.
 $I_{DS(MAX)} = 1.26$ A, $V_{DS(MAX)} = 123.6$ V.

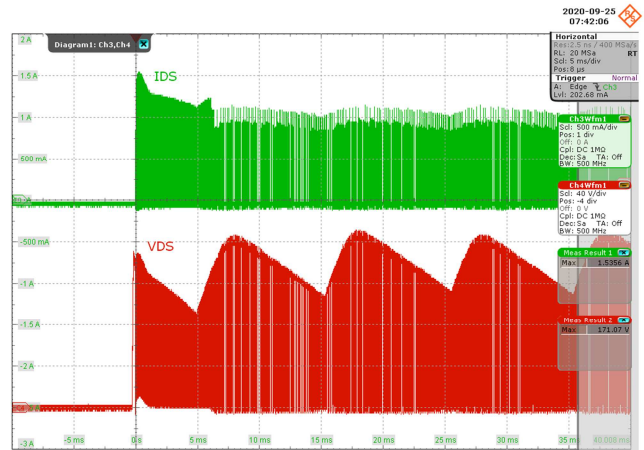

Figure 28 – Drain Voltage and Current Waveforms.
 115 VAC, 550 mA Output.
 Upper: I_{DS} , 500 mA / div.
 Lower: V_{DS} , 40 V / div., 5 ms / div.
 $I_{DS(MAX)} = 1.54$ A, $V_{DS(MAX)} = 171.1$ V.

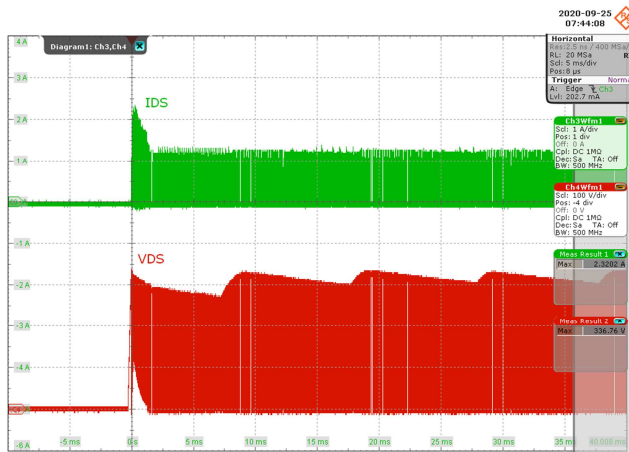

Figure 29 – Drain Voltage and Current Waveforms.
 230 VAC, 550 mA Output.
 Upper: I_{DS} , 1 A / div.
 Lower: V_{DS} , 100 V / div., 5 ms / div.
 $I_{DS(MAX)} = 2.32$ A, $V_{DS(MAX)} = 336.8$ V.

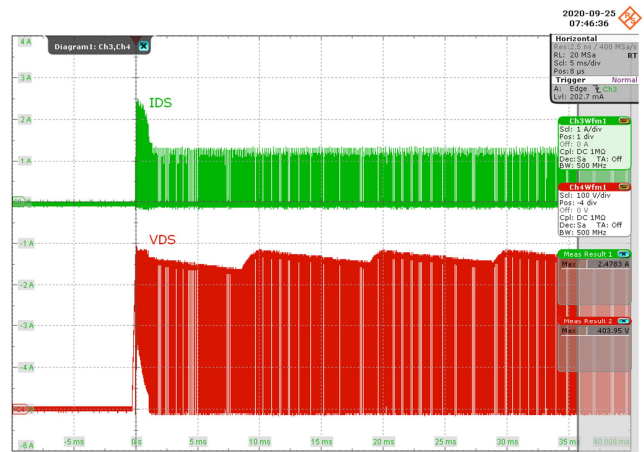

Figure 30 – Drain Voltage and Current Waveforms.
 265 VAC, 550 mA Output.
 Upper: I_{DS} , 1 A / div.
 Lower: V_{DS} , 100 V / div., 5 ms / div.
 $I_{DS(MAX)} = 2.48$ A, $V_{DS(MAX)} = 404.0$ V.



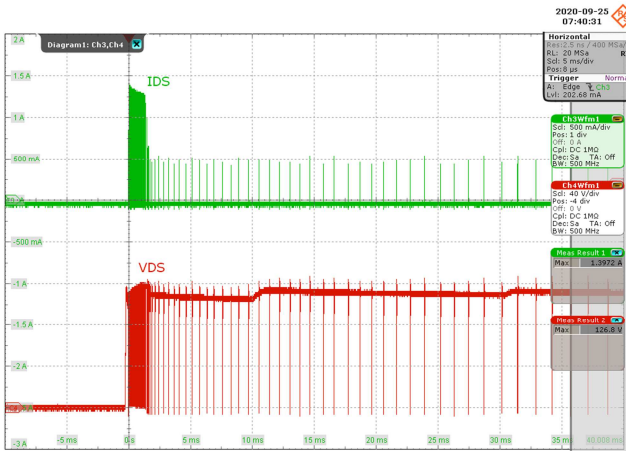

Figure 31 – Drain Voltage and Current Waveforms.
 85 VAC, 0 mA Output.
 Upper: I_{DS} , 500 mA / div.
 Lower: V_{DS} , 40 V / div., 5 ms / div.
 $I_{DS(MAX)} = 1.40 \text{ A}$, $V_{DS(MAX)} = 126.8 \text{ V}$.

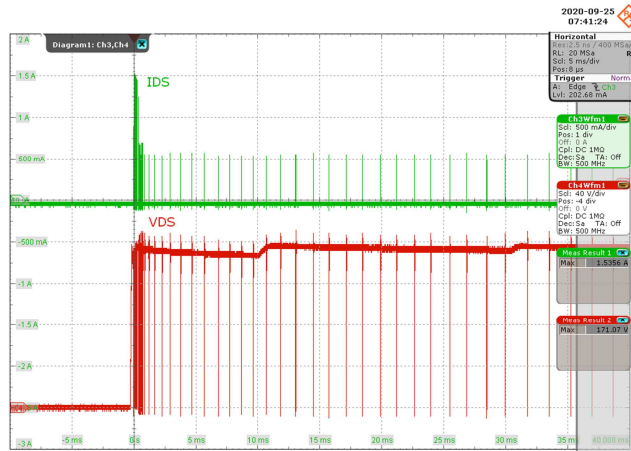

Figure 32 – Drain Voltage and Current Waveforms.
 115 VAC, 0 mA Output.
 Upper: I_{DS} , 500 mA / div.
 Lower: V_{DS} , 40 V / div., 5 ms / div.
 $I_{DS(MAX)} = 1.54 \text{ A}$, $V_{DS(MAX)} = 171.1 \text{ V}$.

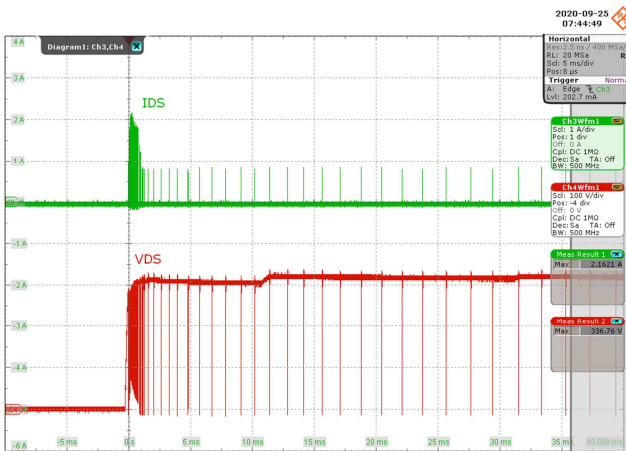

Figure 33 – Drain Voltage and Current Waveforms.
 230 VAC, 0 mA Output.
 Upper: I_{DS} , 1 A / div.
 Lower: V_{DS} , 100 V / div., 5 ms / div.
 $I_{DS(MAX)} = 2.16 \text{ A}$, $V_{DS(MAX)} = 336.8 \text{ V}$.

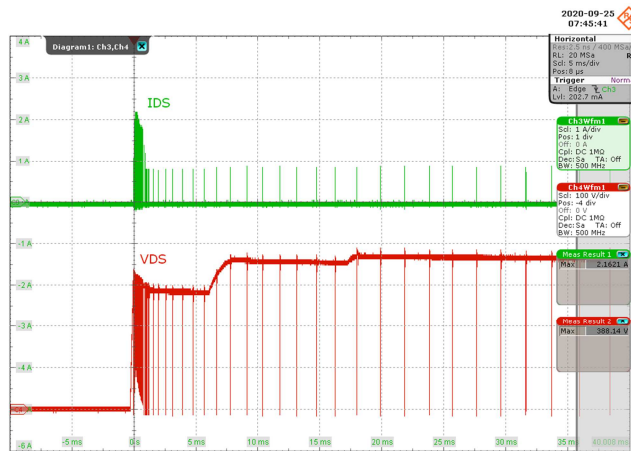

Figure 34 – Drain Voltage and Current Waveforms.
 265 VAC, 0 mA Output.
 Upper: I_{DS} , 1 A / div.
 Lower: V_{DS} , 100 V / div., 5 ms / div.
 $I_{DS(MAX)} = 2.16 \text{ A}$, $V_{DS(MAX)} = 388.1 \text{ V}$.

11.1.3 Drain Current and Output Waveform During Output Short

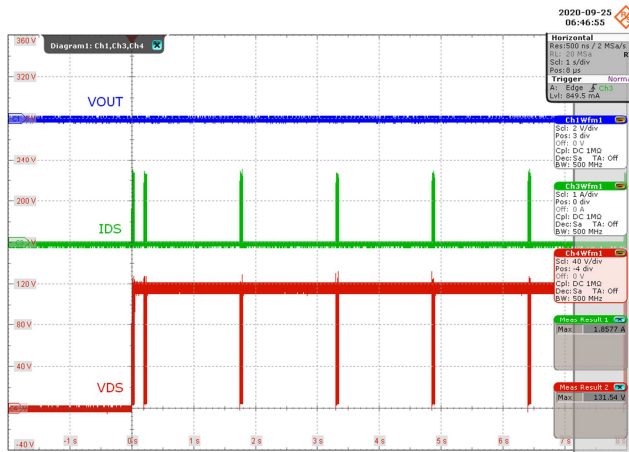

Figure 35 – Drain Current and Output Waveforms.
85 VAC Input.
Upper: V_{OUT}, 2 V / div, 1 s / div.
Middle: I_{DS}, 1 A / div.
Lower: V_{DS}, 40 V / div.

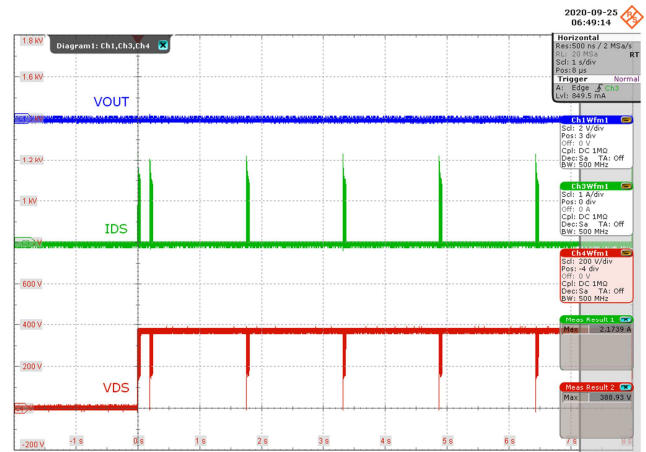

Figure 36 – Drain Voltage and Output Waveforms.
265 VAC Input.
Upper: V_{OUT}, 2 V / div, 1 s / div.
Middle: I_{DS}, 1 A / div.
Lower: V_{DS}, 200 V / div.

11.1.4 Freewheeling Diode Waveforms

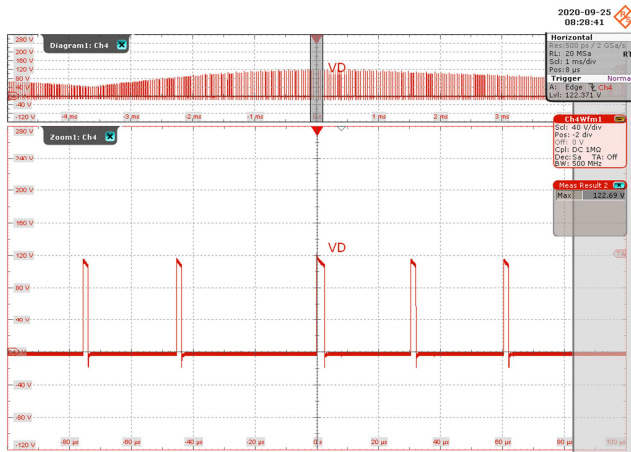

Figure 37 – Freewheeling Diode Voltage Waveforms.
85 VAC, 550 mA Output.
40 V / div., 20 μs / div.
 V_{MAX} : 122.7 V.

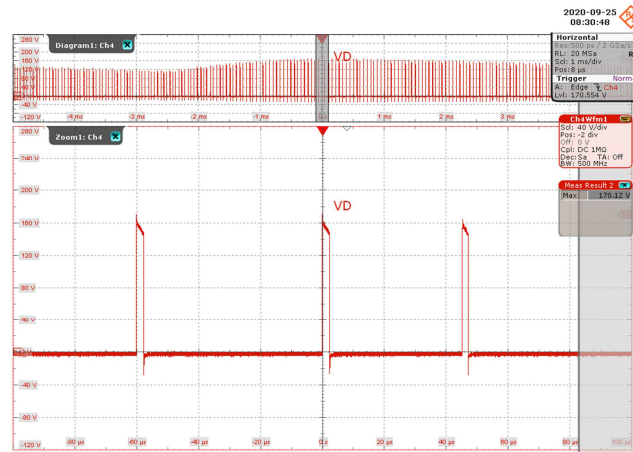

Figure 38 – Freewheeling Diode Voltage Waveforms.
115 VAC, 550 mA Output.
40 V / div., 20 μs / div.
 V_{MAX} : 170.1 V.

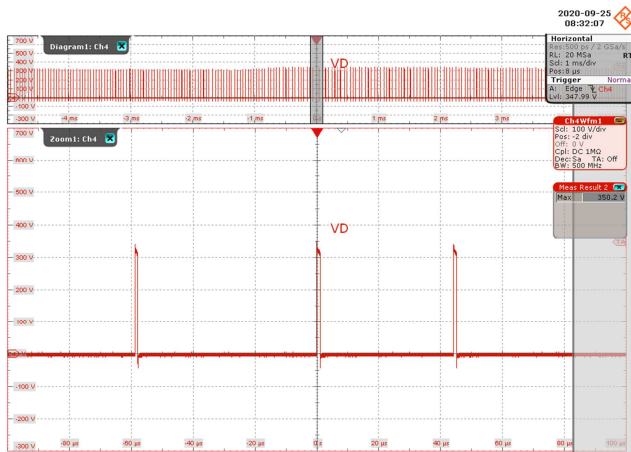

Figure 39 – Freewheeling Diode Voltage Waveforms.
230 VAC, 550 mA Output.
100 V / div., 20 μs / div.
 V_{MAX} : 350.2 V.

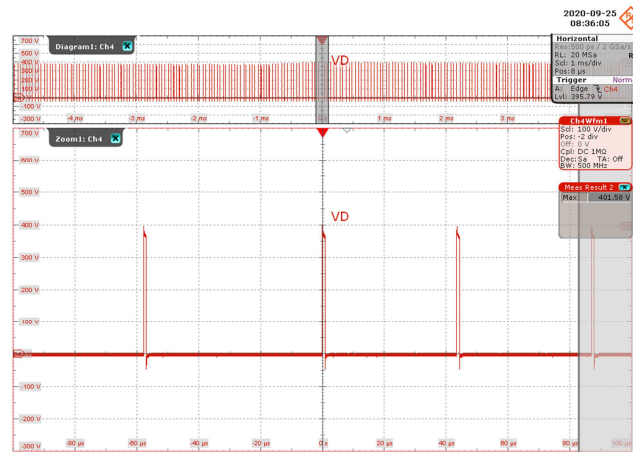

Figure 40 – Freewheeling Diode Voltage Waveforms.
265 VAC, 550 mA Output.
100 V / div., 20 μs / div.
 V_{MAX} : 401.6 V.

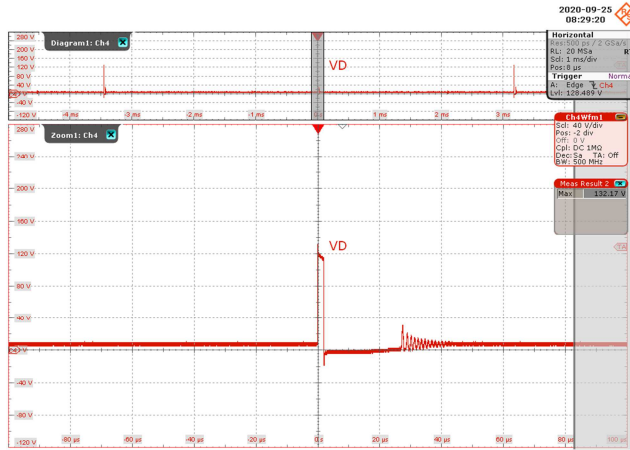

Figure 41 – Freewheeling Diode Voltage Waveforms.
85 VAC, 0 mA Output.
40 V / div., 20 μs / div.
 V_{MAX} : 132.2 V.

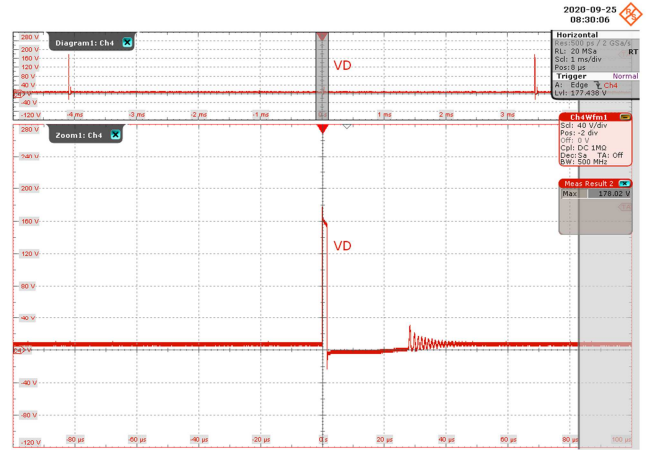

Figure 42 – Freewheeling Diode Voltage Waveforms.
115 VAC, 0 mA Output.
40 V / div., 20 μs / div.
 V_{MAX} : 178.0 V.

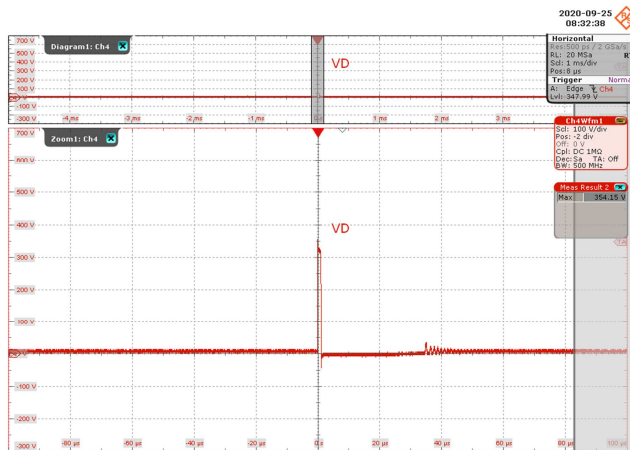

Figure 43 – Freewheeling Diode Voltage Waveforms.
230 VAC, 0 mA Output.
100 V / div., 20 μs / div.
 V_{MAX} : 354.2 V.

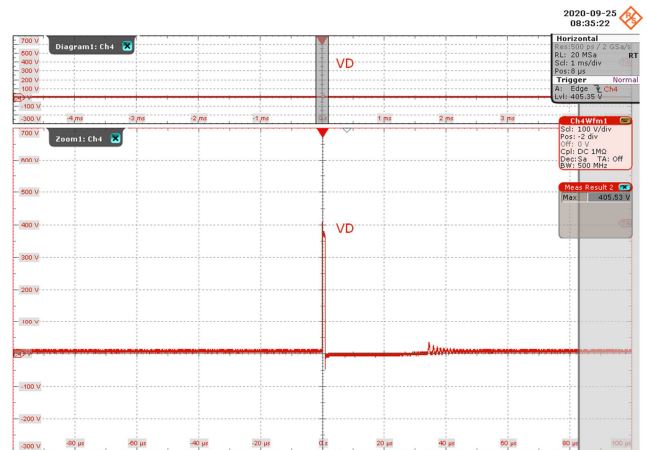

Figure 44 – Freewheeling Diode Voltage Waveforms.
265 VAC, 0 mA Output.
100 V / div., 20 μs / div.
 V_{MAX} : 405.5 V.



11.1.5 Freewheeling Diode Waveforms During Startup

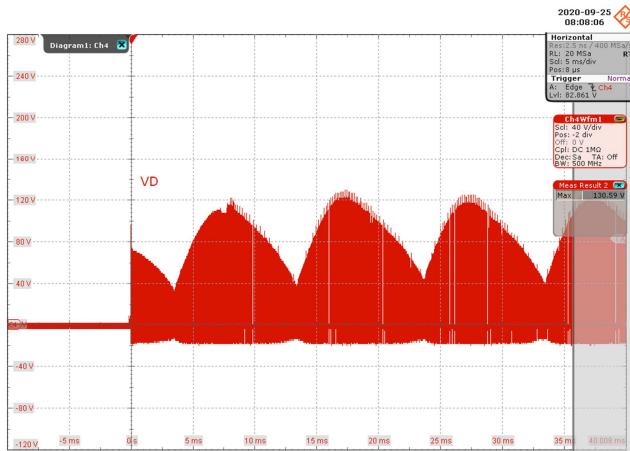

Figure 45 – Freewheeling Diode Voltage Waveforms.
85 VAC, 550 mA Output.
40 V / div., 5 ms / div.
 V_{MAX} : 130.6 V.

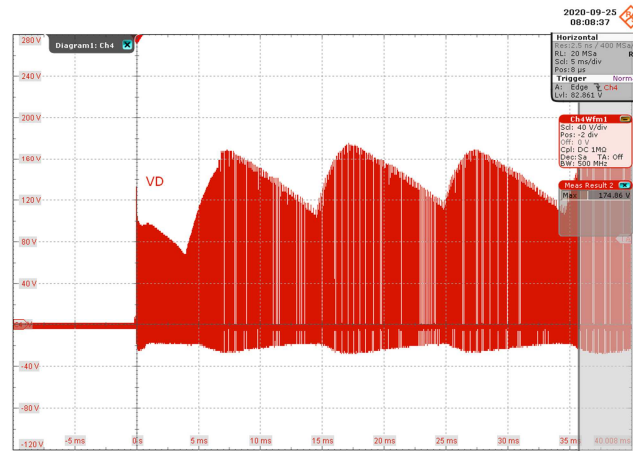

Figure 46 – Freewheeling Diode Voltage Waveforms.
115 VAC, 550 mA Output.
40 V / div., 5 ms / div.
 V_{MAX} : 174.9 V.

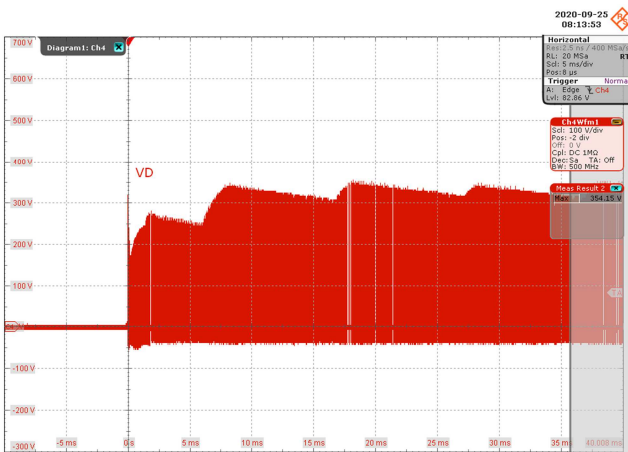

Figure 47 – Freewheeling Diode Voltage Waveforms.
230 VAC, 550 mA Output.
100 V / div., 5 ms / div.
 V_{MAX} : 354.2 V.

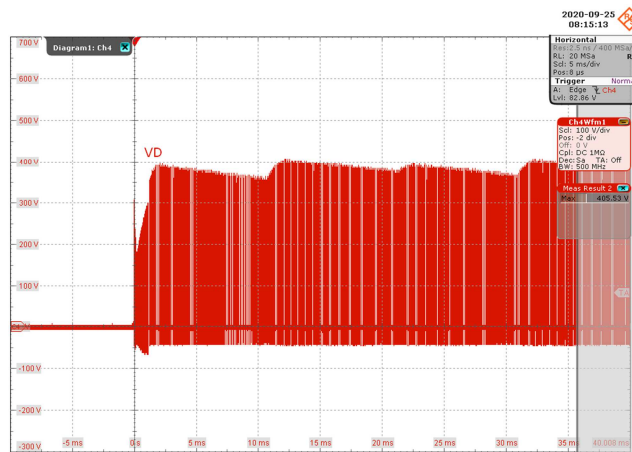

Figure 48 – Freewheeling Diode Voltage Waveforms.
265 VAC, 550 mA Output.
100 V / div., 5 ms / div.
 V_{MAX} : 405.5 V.

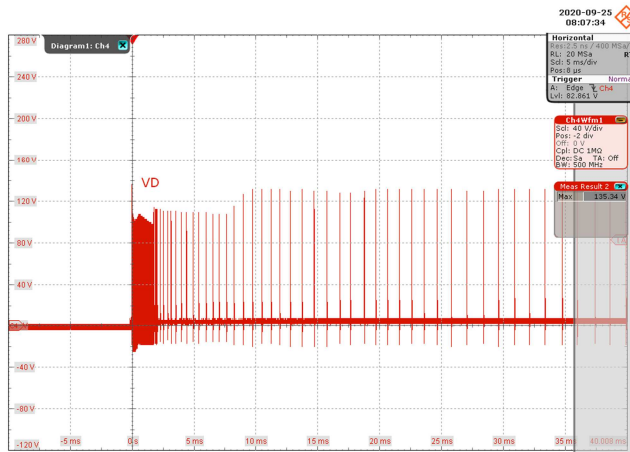

Figure 49 – Freewheeling Diode Voltage Waveforms.
 85 VAC, 0 mA Output.
 40 V / div., 5 ms / div.
 V_{MAX} : 135.3 V.

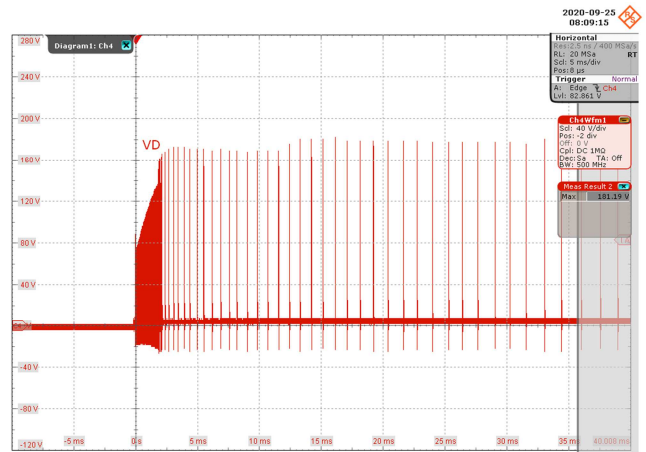

Figure 50 – Freewheeling Diode Voltage Waveforms.
 115 VAC, 0 mA Output.
 40 V / div., 5 ms / div.
 V_{MAX} : 181.2 V.

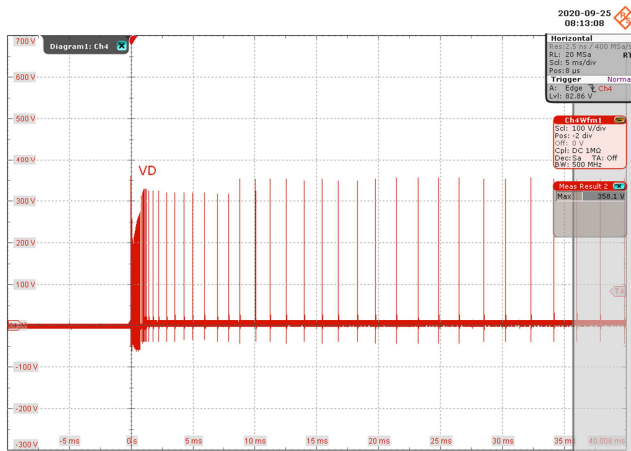

Figure 51 – Freewheeling Diode Voltage Waveforms.
 230 VAC, 0 mA Output.
 100 V / div., 5 ms / div.
 V_{MAX} : 358.1 V.

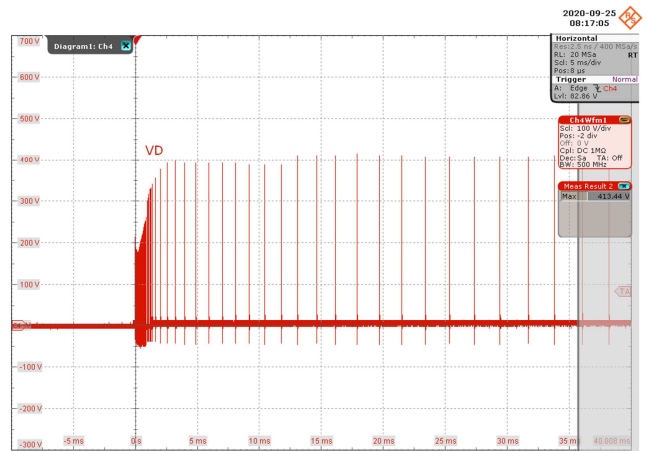

Figure 52 – Freewheeling Diode Voltage Waveforms.
 265 VAC, 0 mA Output.
 100 V / div., 5 ms / div.
 V_{MAX} : 413.4 V.

11.1.6 Output Voltage and Current Waveforms During Start-Up (CC Mode)

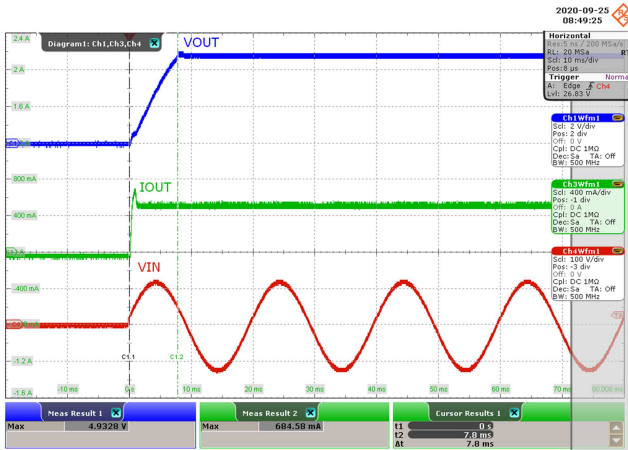

Figure 53 – Output Voltage and Current Waveforms. 85 VAC, 550 mA Output.
 Upper: V_{OUT} , 2 V / div., 10 ms / div.
 Middle: I_{OUT} 400 mA / div.
 Lower: V_{IN} , 100 V / div.
 Rise Time = 7.8 ms.

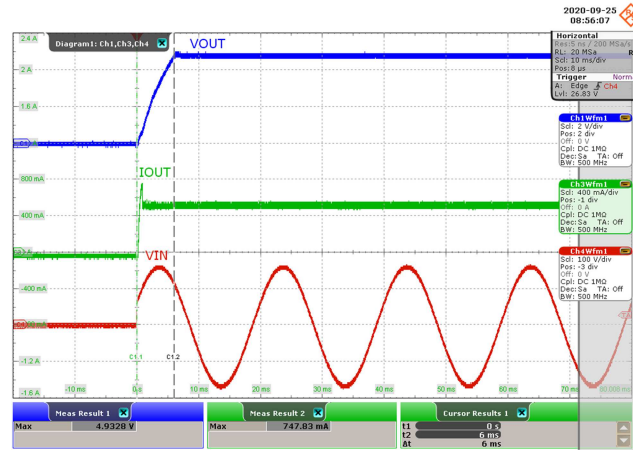

Figure 54 – Output Voltage and Current Waveforms. 115 VAC, 550 mA Output.
 Upper: V_{OUT} , 2 V / div., 10 ms / div.
 Middle: I_{OUT} 400 mA / div.
 Lower: V_{IN} , 100 V / div.
 Rise Time = 6 ms.

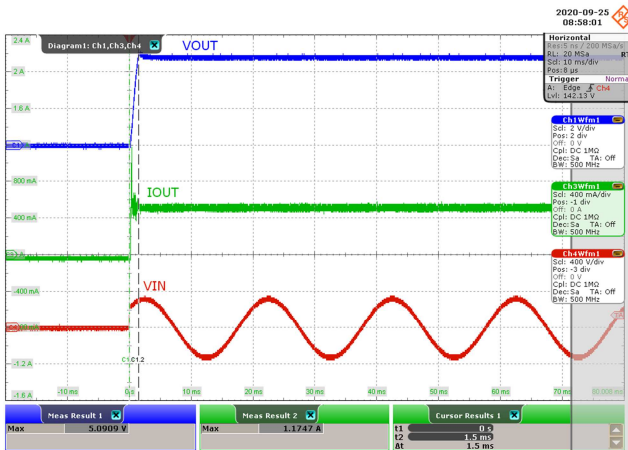

Figure 55 – Output Voltage and Current Waveforms. 230 VAC, 550 mA Output.
 Upper: V_{OUT} , 2 V / div., 10 ms / div.
 Middle: I_{OUT} 400 mA / div.
 Lower: V_{IN} , 400 V / div.
 Rise Time = 1.5 ms.

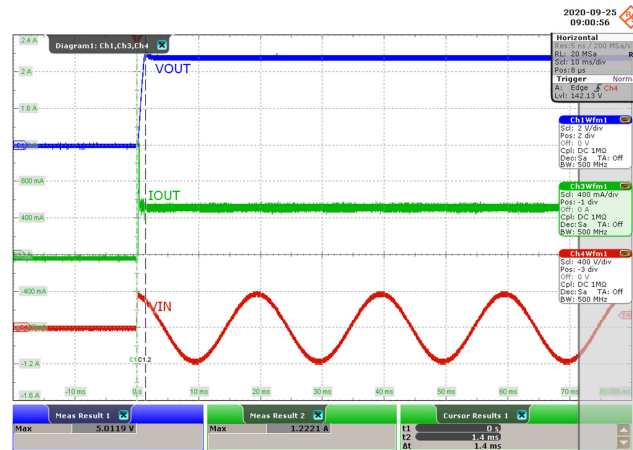

Figure 56 – Output Voltage and Current Waveforms. 265 VAC, 550 mA Output.
 Upper: V_{OUT} , 2 V / div., 10 ms / div.
 Middle: I_{OUT} 400 mA / div.
 Lower: V_{IN} , 400 V / div.
 Rise Time = 1.4 ms.

11.1.8 Output Voltage and Current Waveforms During Start-Up (Min Load)

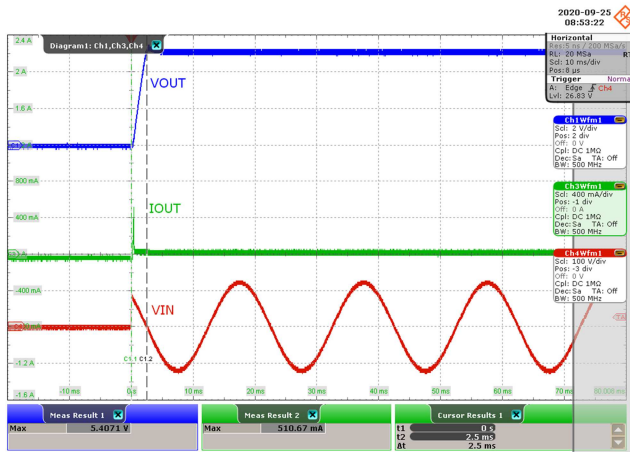

Figure 61 – Output Voltage and Current Waveforms. 85 VAC, 27.5 mA Output.
Upper: V_{OUT} , 2 V / div., 10 ms / div.
Middle: I_{OUT} 400 mA / div.
Lower: V_{IN} , 100 V / div.
Rise Time = 2.5 ms.

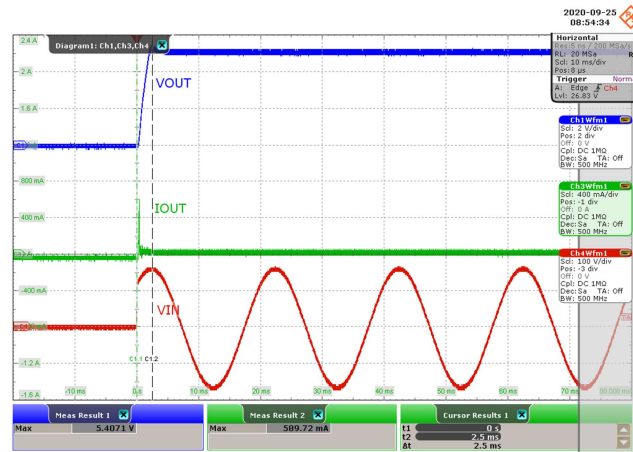

Figure 62 – Output Voltage and Current Waveforms. 115 VAC, 27.5 mA Output.
Upper: V_{OUT} , 2 V / div., 10 ms / div.
Middle: I_{OUT} 400 mA / div.
Lower: V_{IN} , 100 V / div.
Rise Time = 2.5 ms.

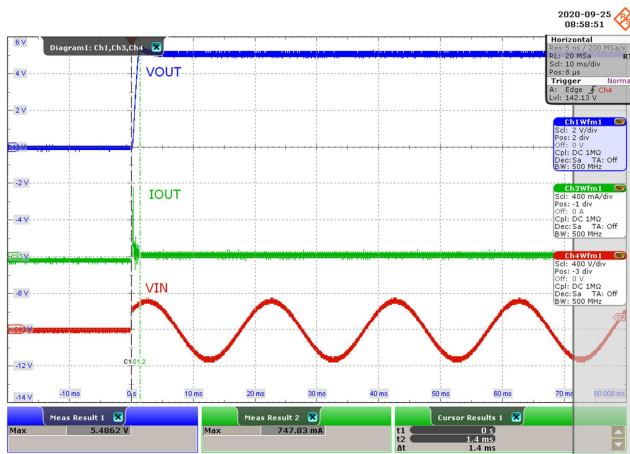

Figure 63 – Output Voltage and Current Waveforms. 85 VAC, 27.5 mA Output.
Upper: V_{OUT} , 2 V / div., 10 ms / div.
Middle: I_{OUT} 400 mA / div.
Lower: V_{IN} , 400 V / div.
Rise Time = 1.4 ms.

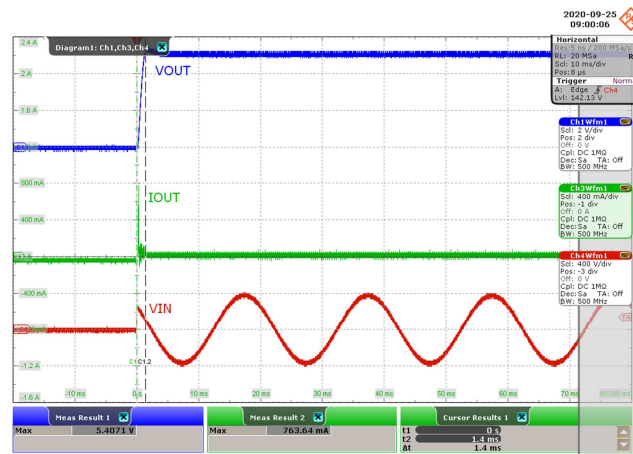

Figure 64 – Output Voltage and Current Waveforms. 265 VAC, 27.5 mA Output.
Upper: V_{OUT} , 2 V / div., 10 ms / div.
Middle: I_{OUT} 400 mA / div.
Lower: V_{IN} , 400 V / div.
Rise Time = 1.4 ms.

11.2 **Output Ripple Measurements**

11.2.1 Ripple Measurement Set-up

For DC output ripple measurements, a modified oscilloscope test probe must be utilized in order to reduce spurious signals due to pick-up. Details of the probe modification are provided in the Figures below.

The 4987BA probe adapter is affixed with two capacitors tied in parallel across the probe tip. The capacitors include one (1) 0.1 μF /50 V ceramic type and one (1) 1 μF /50 V aluminum electrolytic. The aluminum electrolytic type capacitor is polarized, so proper polarity across DC outputs must be maintained (see below).

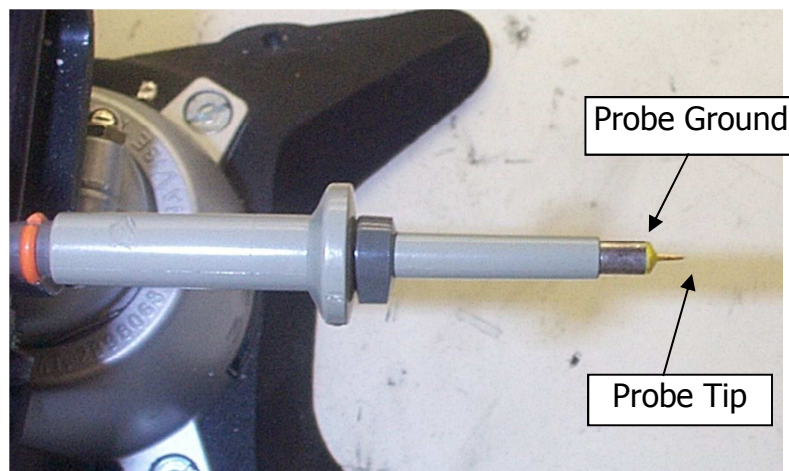

Figure 65 – Oscilloscope Probe Prepared for Ripple Measurement. (End Cap and Ground Lead Removed.)

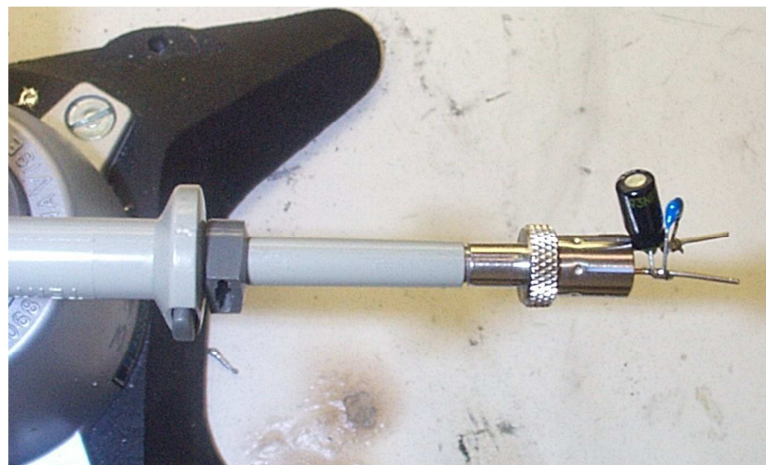

Figure 66 – Oscilloscope Probe with Probe Master (www.probemaster.com) 4987A BNC Adapter. (Modified with wires for ripple measurement, and two parallel decoupling capacitors added.)

11.2.2 Measurement Results

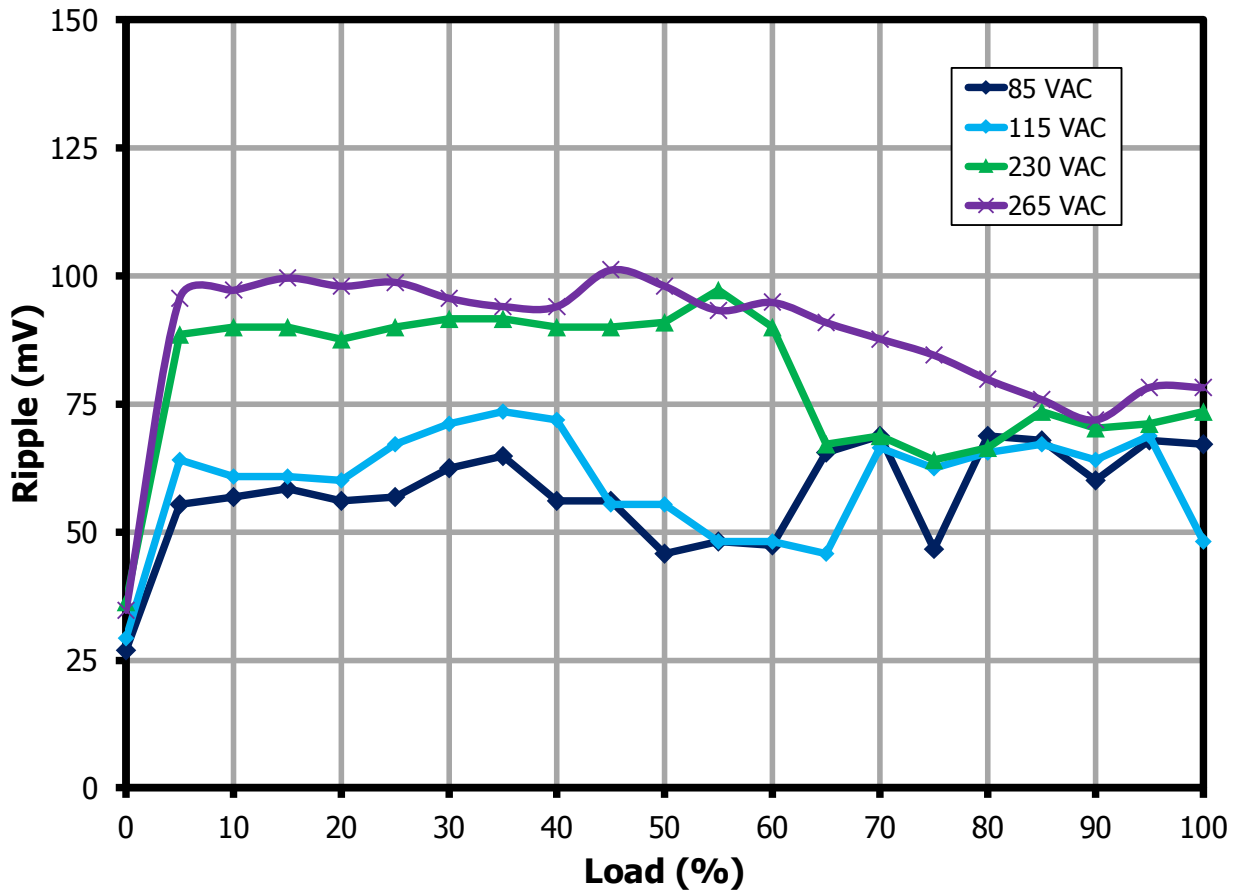

Figure 67 – Output Ripple Voltage.

11.2.3 Ripple Voltage Waveforms

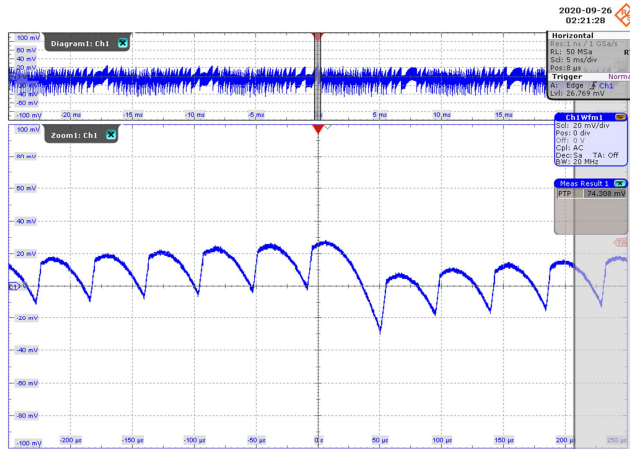

Figure 68 – Output Voltage Ripple Waveforms.
 85 VAC, 550 mA Output.
 20 mV, 5 ms / div.; 50 μs / div.
 V_{PK-PK} : 74.3 mV.

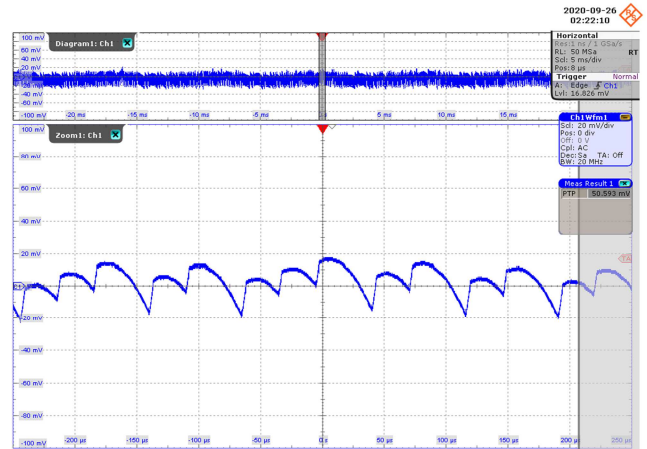

Figure 69 – Output Voltage Ripple Waveforms.
 85VAC, 412.5 mA Output.
 20 mV, 5 ms / div.; 50 μs / div.
 V_{PK-PK} : 50.6 mV.

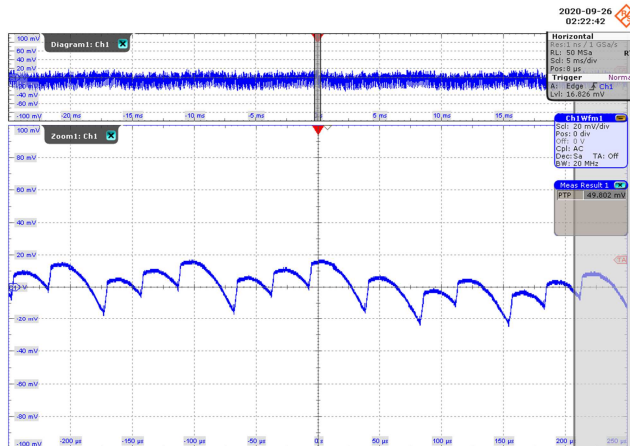

Figure 70 – Output Voltage Ripple Waveforms.
 85 VAC, 275 mA Output.
 20 mV, 5 ms / div.; 50 μs / div.
 V_{PK-PK} : 49.8 mV.

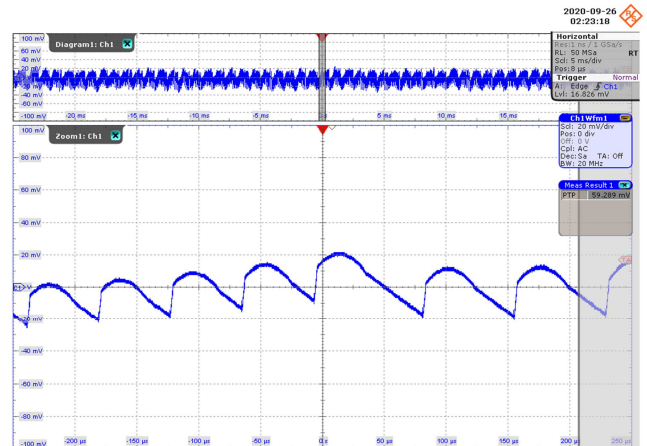

Figure 71 – Output Voltage Ripple Waveforms.
 85 VAC, 137.5 mA Output.
 20 mV, 5 ms / div.; 50 μs / div.
 V_{PK-PK} : 59.3 mV.



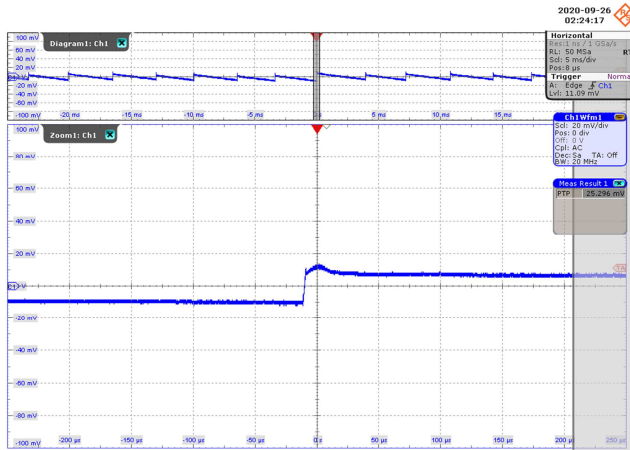

Figure 72 – Output Voltage Ripple Waveforms.
85 VAC, 0 mA Output.
20 mV, 5 ms / div.; 50 μ s / div.
 V_{PK-PK} : 25.3 mV.

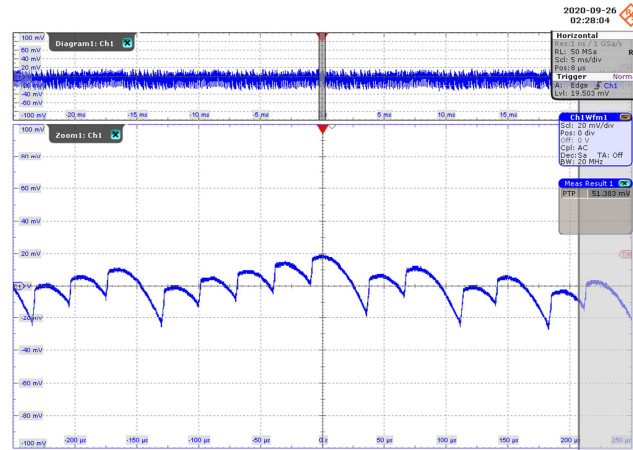

Figure 73 – Output Voltage Ripple Waveforms.
115VAC, 550 mA Output.
20 mV, 5 ms / div.; 50 μ s / div.
 V_{PK-PK} : 51.4 mV.

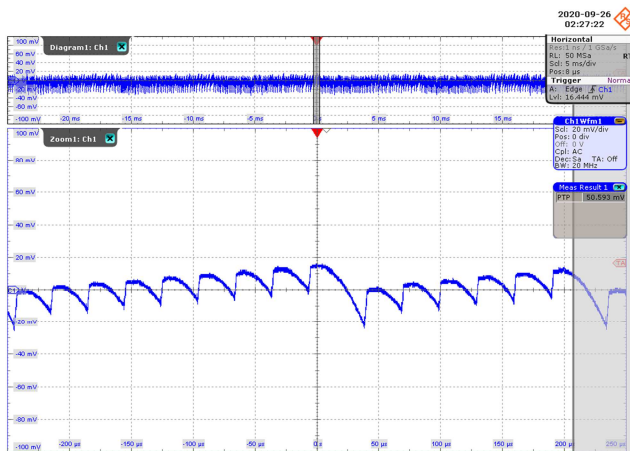

Figure 74 – Output Voltage Ripple Waveforms.
115 VAC, 412.5 mA Output.
20 mV, 5 ms / div.; 50 μ s / div.
 V_{PK-PK} : 50.6 mV.

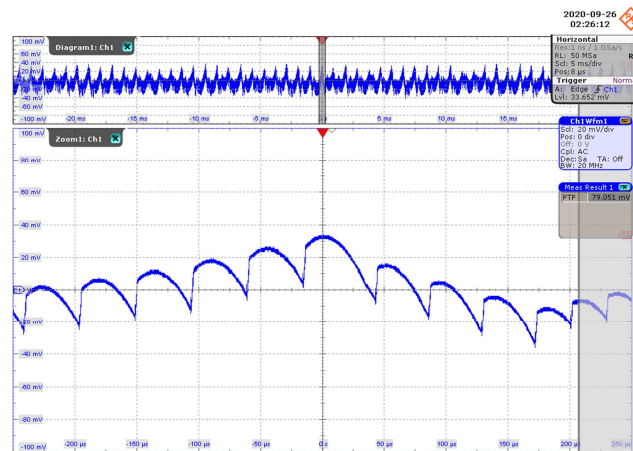

Figure 75 – Output Voltage Ripple Waveforms.
115VAC, 275 mA Output.
20 mV, 5 ms / div.; 50 μ s / div.
 V_{PK-PK} : 79.1 mV.

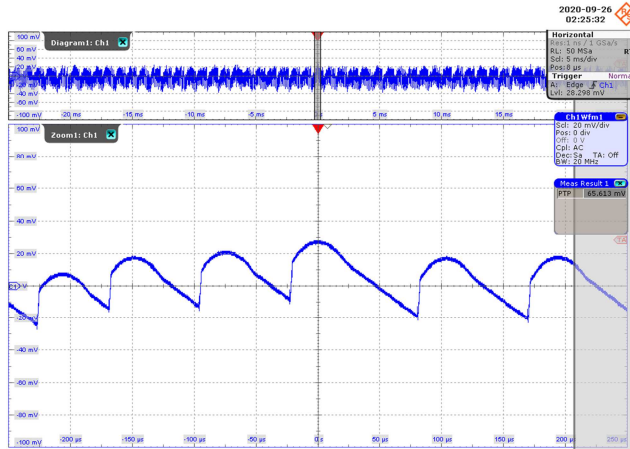

Figure 76 – Output Voltage Ripple Waveforms.
 115 VAC, 137.5 mA Output.
 20 mV, 5 ms / div.; 50 μ s / div.
 V_{PK-PK} : 65.6 mV.

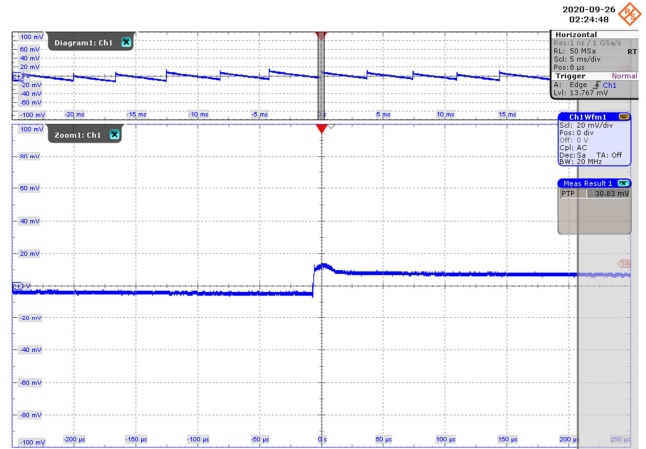

Figure 77 – Output Voltage Ripple Waveforms.
 115VAC, 0 mA Output.
 20 mV, 5 ms / div.; 50 μ s / div.
 V_{PK-PK} : 30.8 mV.

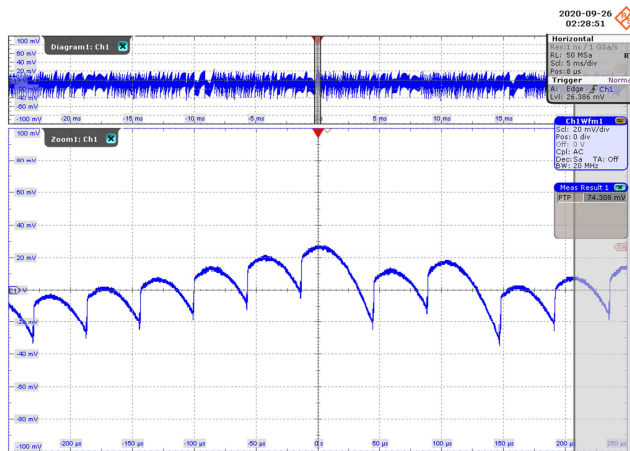

Figure 78 – Output Voltage Ripple Waveforms.
 230 VAC, 550 mA Output.
 20 mV, 5 ms / div.; 50 μ s / div.
 V_{PK-PK} : 74.3 mV.

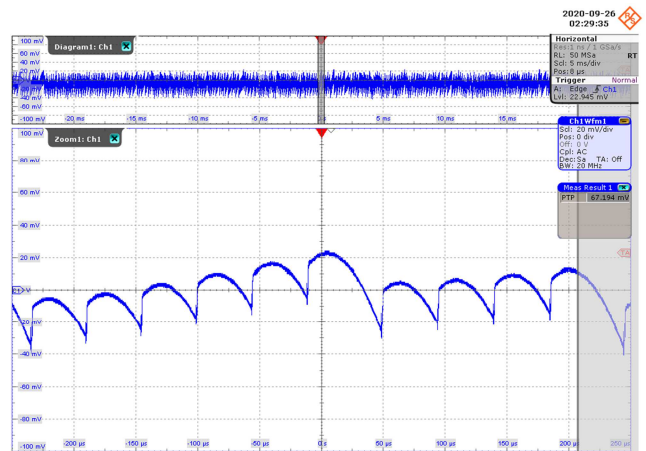

Figure 79 – Output Voltage Ripple Waveforms.
 230VAC, 412.5 mA Output.
 20 mV, 5 ms / div.; 50 μ s / div.
 V_{PK-PK} : 67.2 mV.



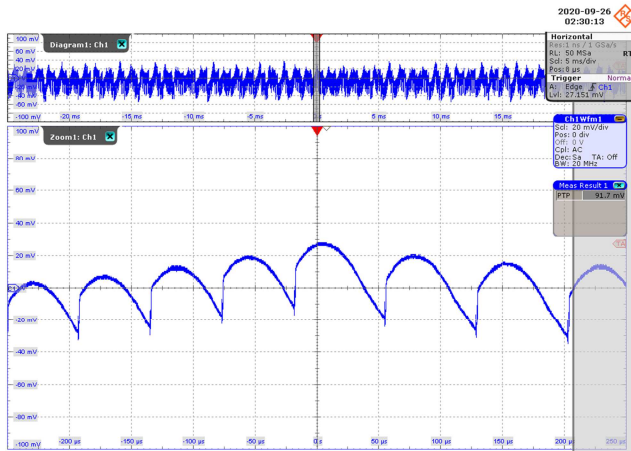

Figure 80 – Output Voltage Ripple Waveforms.
 230 VAC, 275 mA Output.
 20 mV, 5 ms / div.; 50 μs / div.
 V_{PK-PK} : 91.7 mV.

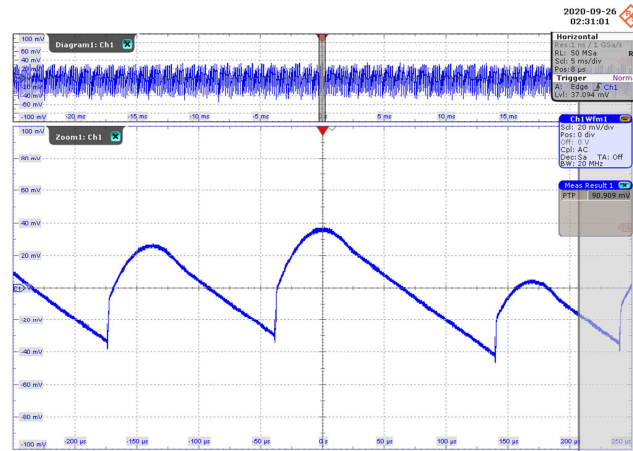

Figure 81 – Output Voltage Ripple Waveforms.
 230 VAC, 137.5 mA Output.
 20 mV, 5 ms / div.; 50 μs / div.
 V_{PK-PK} : 90.9 mV.

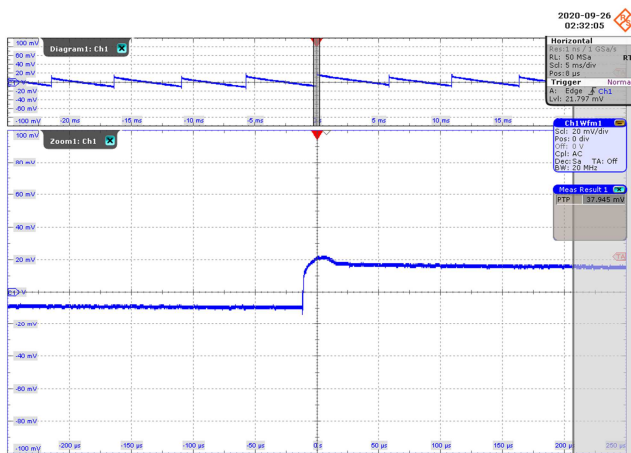

Figure 82 – Output Voltage Ripple Waveforms.
 230 VAC, 0 mA Output.
 20 mV, 5 ms / div.; 50 μs / div.
 V_{PK-PK} : 37.9 mV.

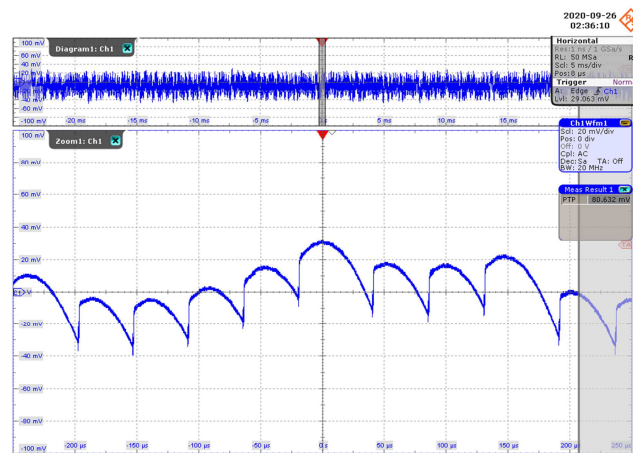

Figure 83 – Output Voltage Ripple Waveforms.
 265 VAC, 550 mA Output.
 20 mV, 5 ms / div.; 50 μs / div.
 V_{PK-PK} : 80.6 mV.

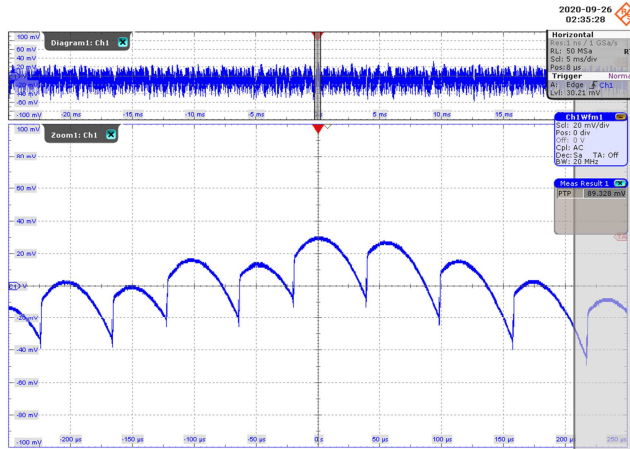

Figure 84 – Output Voltage Ripple Waveforms.
 265 VAC, 412.5 mA Output.
 20 mV, 5 ms / div.; 50 μ s / div.
 V_{PK-PK} : 89.3 mV.

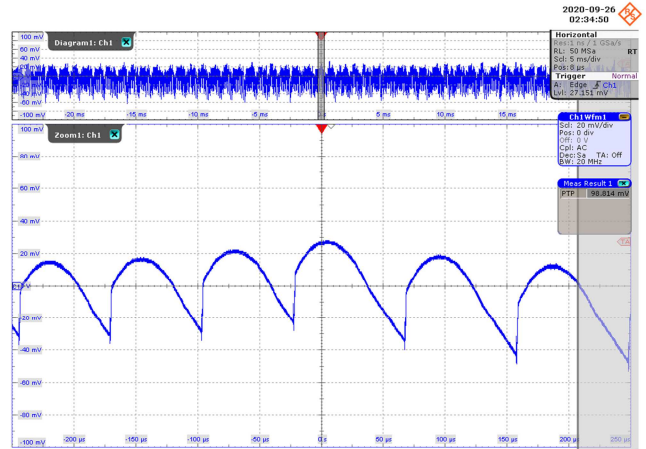

Figure 85 – Output Voltage Ripple Waveforms.
 265 VAC, 275 mA Output.
 20 mV, 5 ms / div.; 50 μ s / div.
 V_{PK-PK} : 98.8 mV.

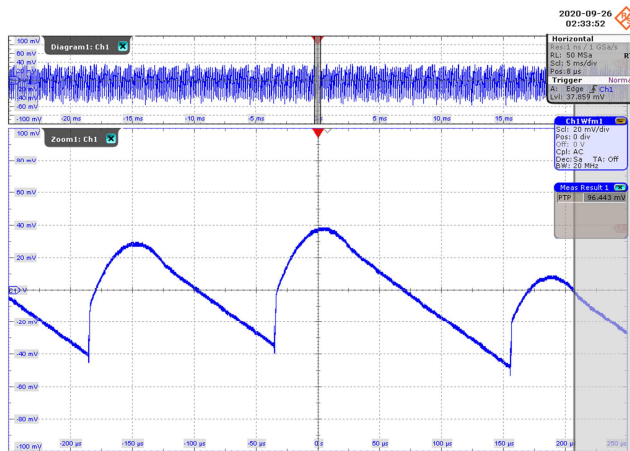

Figure 86 – Output Voltage Ripple Waveforms.
 265 VAC, 137.5 mA Output.
 20 mV, 5 ms / div.; 50 μ s / div.
 V_{PK-PK} : 96.4 mV.

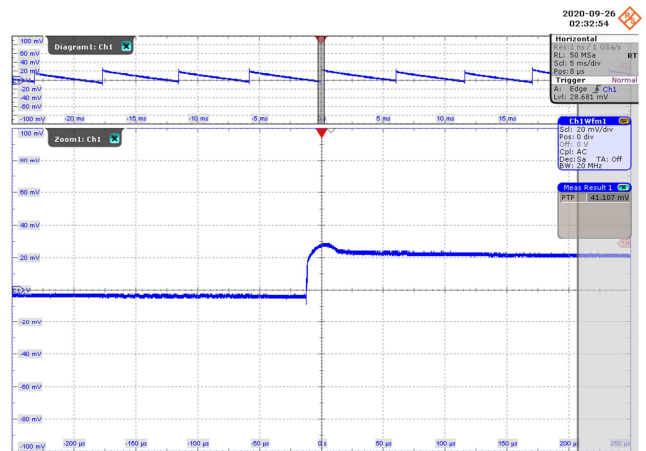

Figure 87 – Output Voltage Ripple Waveforms.
 265 VAC, 0 mA Output.
 20 mV, 5 ms / div.; 50 μ s / div.
 V_{PK-PK} : 41.1 mV.



11.2.4 Transient Response

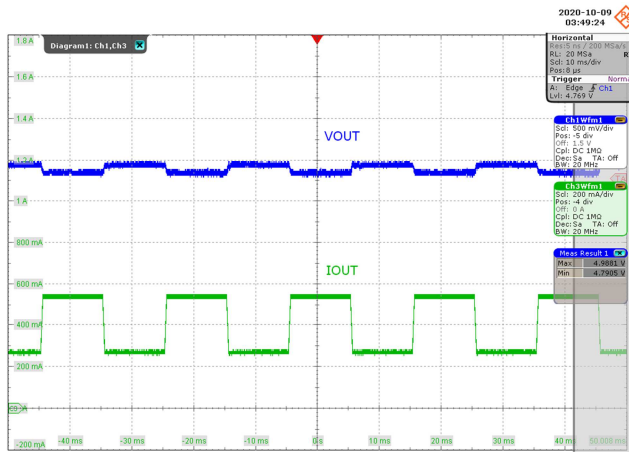

Figure 88 – Transient Output Waveforms.
 85 VAC.
 Upper: V_{OUT} , 500 mV / div, 10 ms / div.
 Lower: I_{OUT} 200 mA / div.
 Load Transient: 50 % - 100%.
 Duty Cycle, Slew Rate: 50%, 0.8 mA / μ s.
 Frequency: 50 Hz.
 V_{MAX} : 4.99 V, V_{MIN} : 4.79 V .

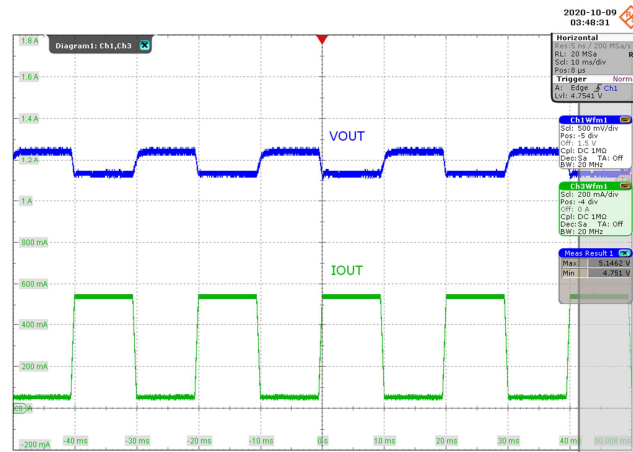

Figure 89 – Transient Output Waveforms.
 85 VAC.
 Upper: V_{OUT} , 500 mV / div, 10 ms / div.
 Lower: I_{OUT} 200 mA / div.
 Load Transient: 10 % - 100%.
 Duty Cycle, Slew Rate: 50%, 0.8 mA / μ s.
 Frequency: 50 Hz.
 V_{MAX} : 5.17 V, V_{MIN} : 4.75 V.

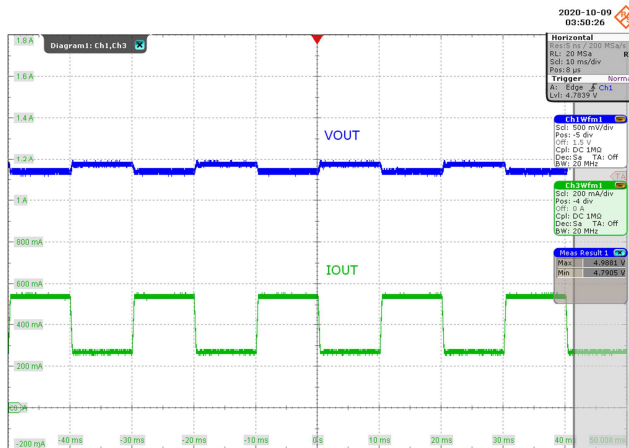

Figure 90 – Transient Output Waveforms.
 115 VAC.
 Upper: V_{OUT} , 500 mV / div, 10 ms / div.
 Lower: I_{OUT} 200 mA / div.
 Load Transient: 50 % - 100%.
 Duty Cycle, Slew Rate: 50%, 0.8 mA / μ s.
 Frequency: 50 Hz.
 V_{MAX} : 4.99 V, V_{MIN} : 4.79 V.

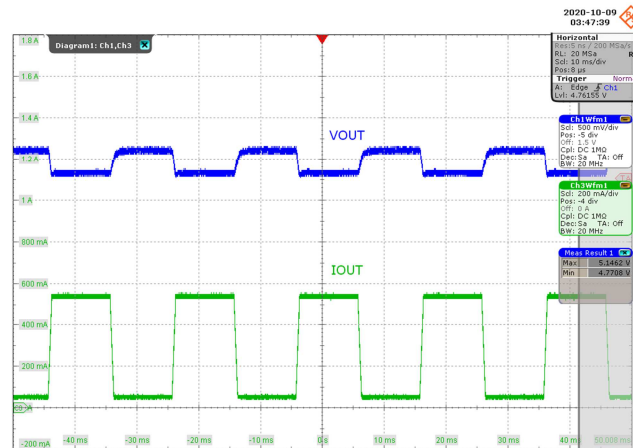

Figure 91 – Transient Output Waveforms.
 115 VAC.
 Upper: V_{OUT} , 500 mV / div, 10 ms / div.
 Lower: I_{OUT} 200 mA / div.
 Load Transient: 10 % - 100%.
 Duty Cycle, Slew Rate: 50%, 0.8 mA / μ s.
 Frequency: 50 Hz.
 V_{MAX} : 5.15 V, V_{MIN} : 4.77 V.

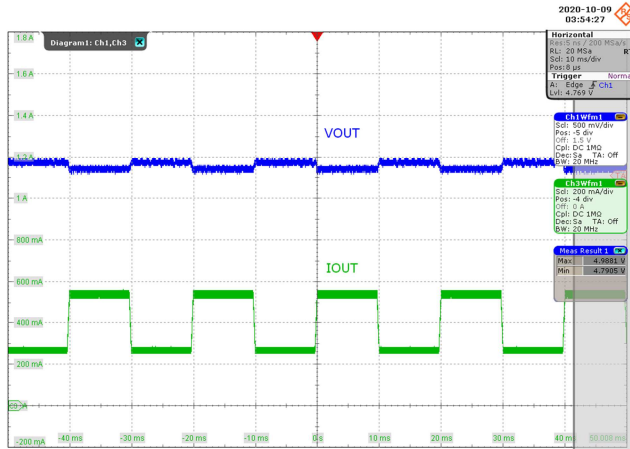

Figure 92 – Transient Output Waveforms.
 230 VAC.
 Upper: V_{OUT} , 500 mV / div, 10 ms / div.
 Lower: I_{OUT} 200 mA / div.
 Load Transient: 50 % - 100%.
 Duty Cycle, Slew Rate: 50%, 0.8 mA / μ s.
 Frequency: 50 Hz.
 V_{MAX} : 4.99 V, V_{MIN} : 4.79 V.

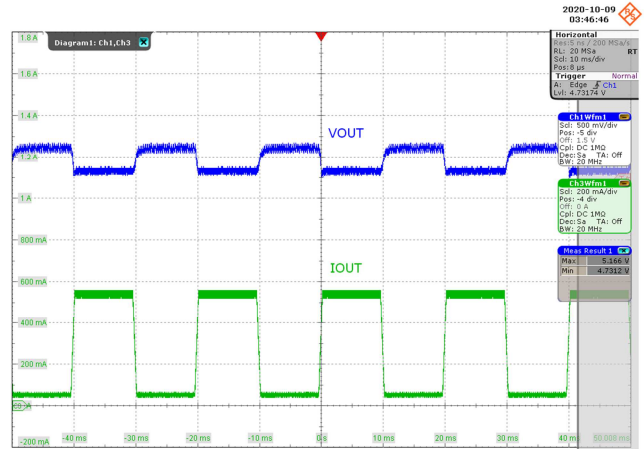

Figure 93 – Transient Output Waveforms.
 230 VAC.
 Upper: V_{OUT} , 500 mV / div, 10 ms / div.
 Lower: I_{OUT} 200 mA / div.
 Load Transient: 10 % - 100%.
 Duty Cycle, Slew Rate: 50%, 0.8 mA / μ s.
 Frequency: 50 Hz.
 V_{MAX} : 5.17 V, V_{MIN} : 4.73 V.

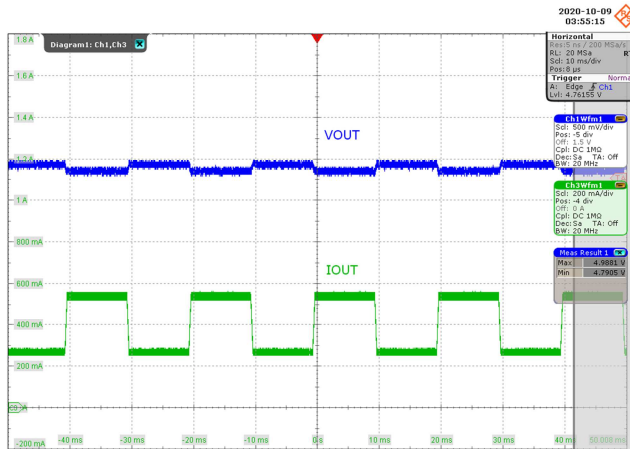

Figure 94 – Transient Output Waveforms.
 265 VAC.
 Upper: V_{OUT} , 500 mV / div, 2 ms / div.
 Lower: I_{OUT} 200 mA / div.
 Load Transient: 50 % - 100%.
 Duty Cycle, Slew Rate: 50%, 0.8 mA / μ s.
 Frequency: 50 Hz.
 V_{MAX} : 4.99 V, V_{MIN} : 4.79 V.

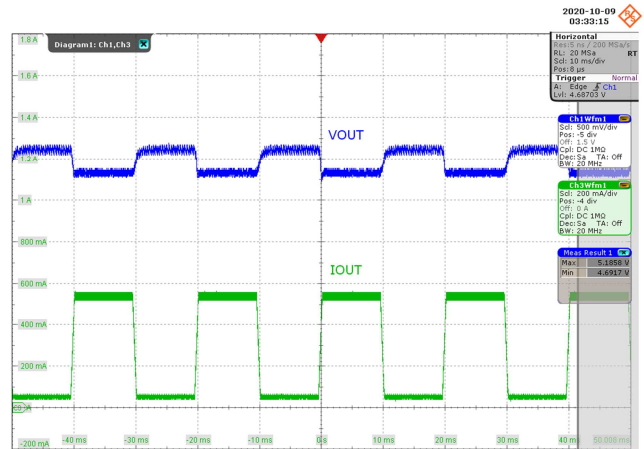

Figure 95 – Transient Output Waveforms.
 265 VAC.
 Upper: V_{OUT} , 500 mV / div, 2 ms / div.
 Lower: I_{OUT} 200 mA / div.
 Load Transient: 10 % - 100%.
 Duty Cycle, Slew Rate: 50%, 0.8 mA / μ s.
 Frequency: 50 Hz.
 V_{MAX} : 5.19 V, V_{MIN} : 4.69 V.

12 Conducted EMI

12.1 550 mA Resistive Load, Floating Output (QPK / AV)

After running for 15 minutes.

12.1.1 115 VAC

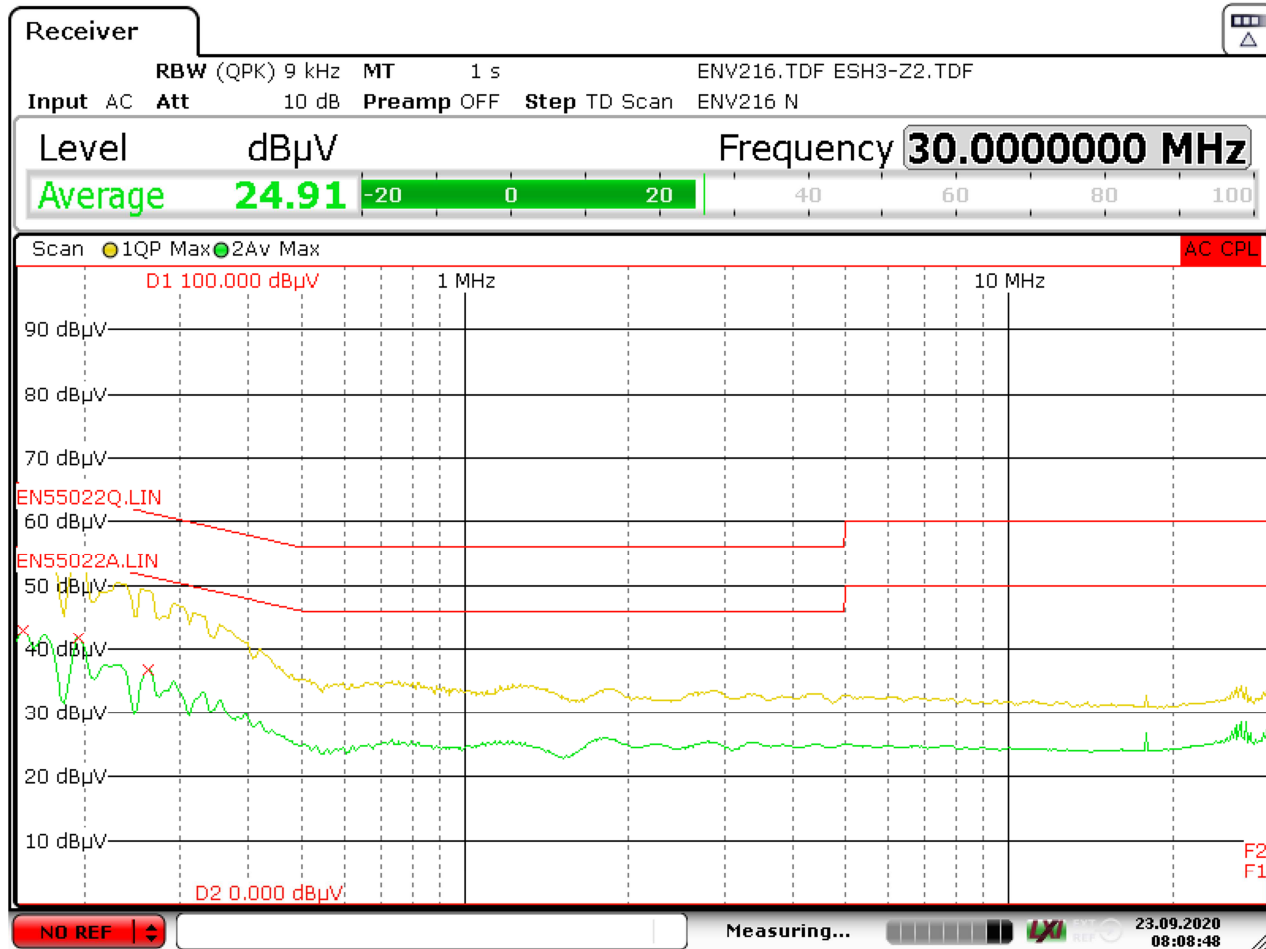

Date: 23.SEP.2020 08:08:48

Figure 96 – Floating Ground EMI at 115 VAC.

12.1.2 230 VAC

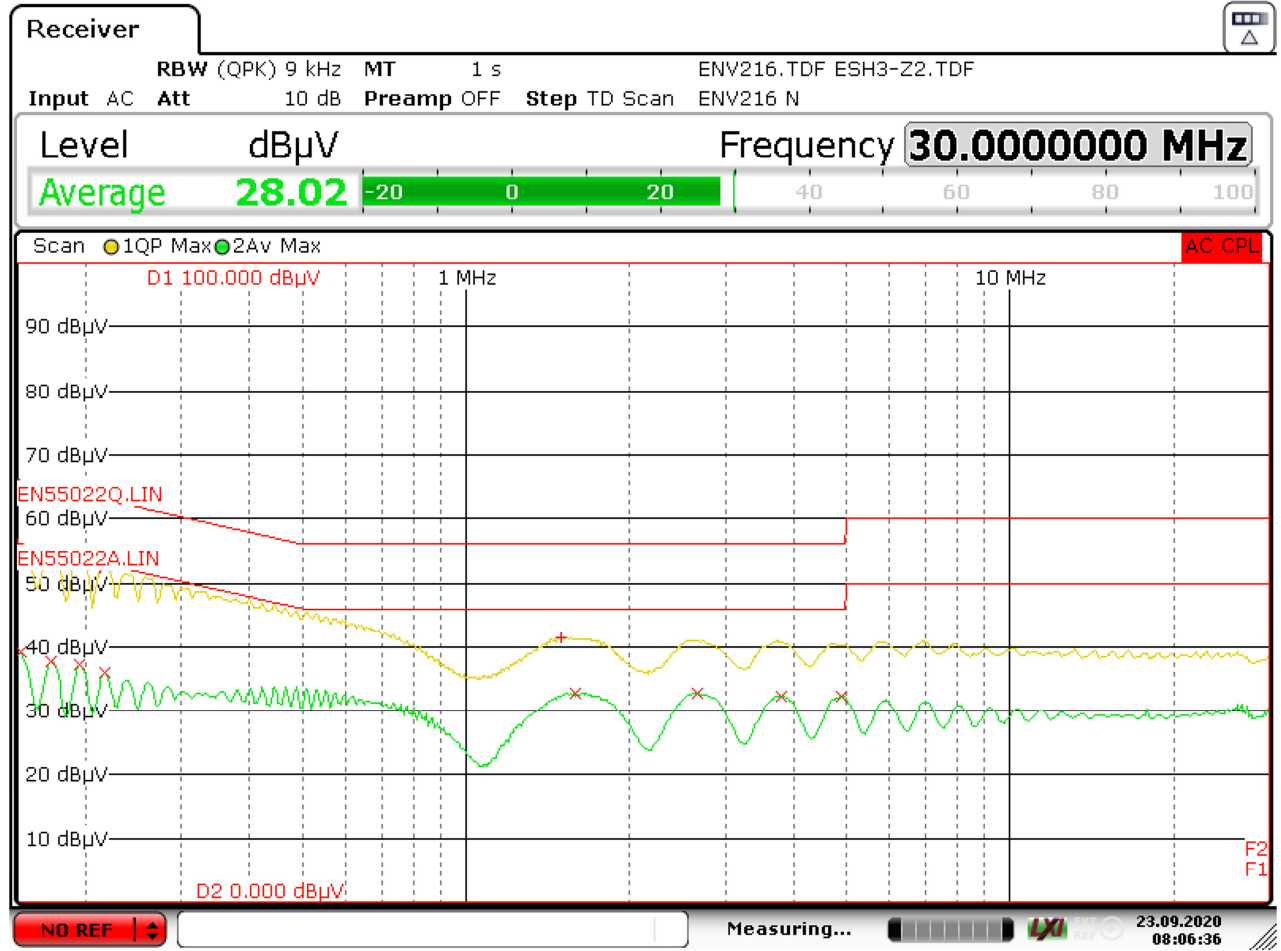

Date: 23.SEP.2020 08:06:36

Figure 97 – Floating Ground at 230 VAC.



13 Lighting Surge

13.1 Differential Mode Test

Passed ±1 kV surge test.

Surge Voltage (kV)	Phase Angle	IEC Coupling	Generator Impedance (Ω)	Number Strikes	Result	Remarks
+1	0	L1 / L2	2	10	PASS	No Auto-restart
-1	0	L1 / L2	2	10	PASS	No Auto-restart
+1	90	L1 / L2	2	10	PASS	No Auto-restart
-1	90	L1 / L2	2	10	PASS	No Auto-restart
+1	180	L1 / L2	2	10	PASS	No Auto-restart
-1	180	L1 / L2	2	10	PASS	No Auto-restart
+1	270	L1 / L2	2	10	PASS	No Auto-restart
-1	270	L1 / L2	2	10	PASS	No Auto-restart

13.1.1 1000 V 90° Differential Mode Surge

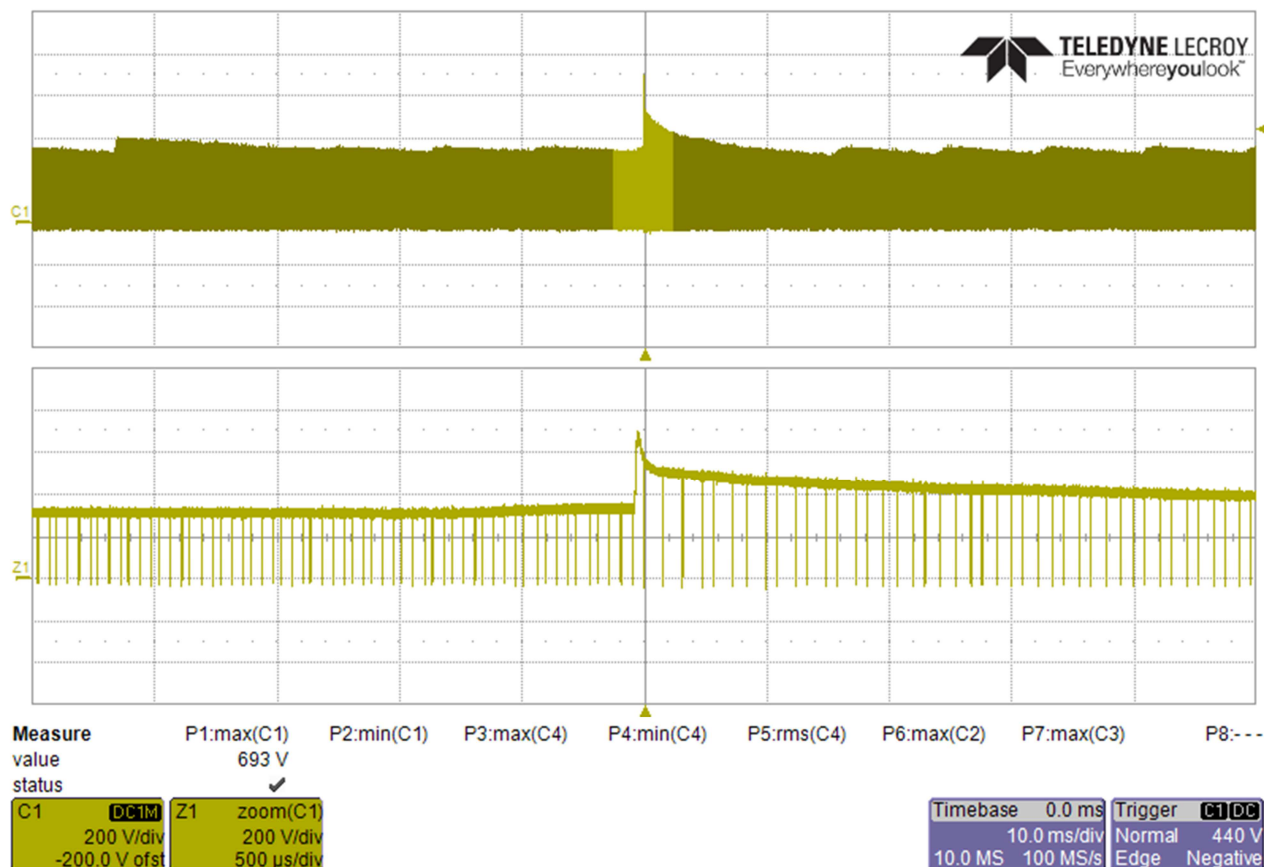

Figure 98 – Drain Voltage, 230 VAC, Full Load.

-1000 V 270° Differential Mode Surge

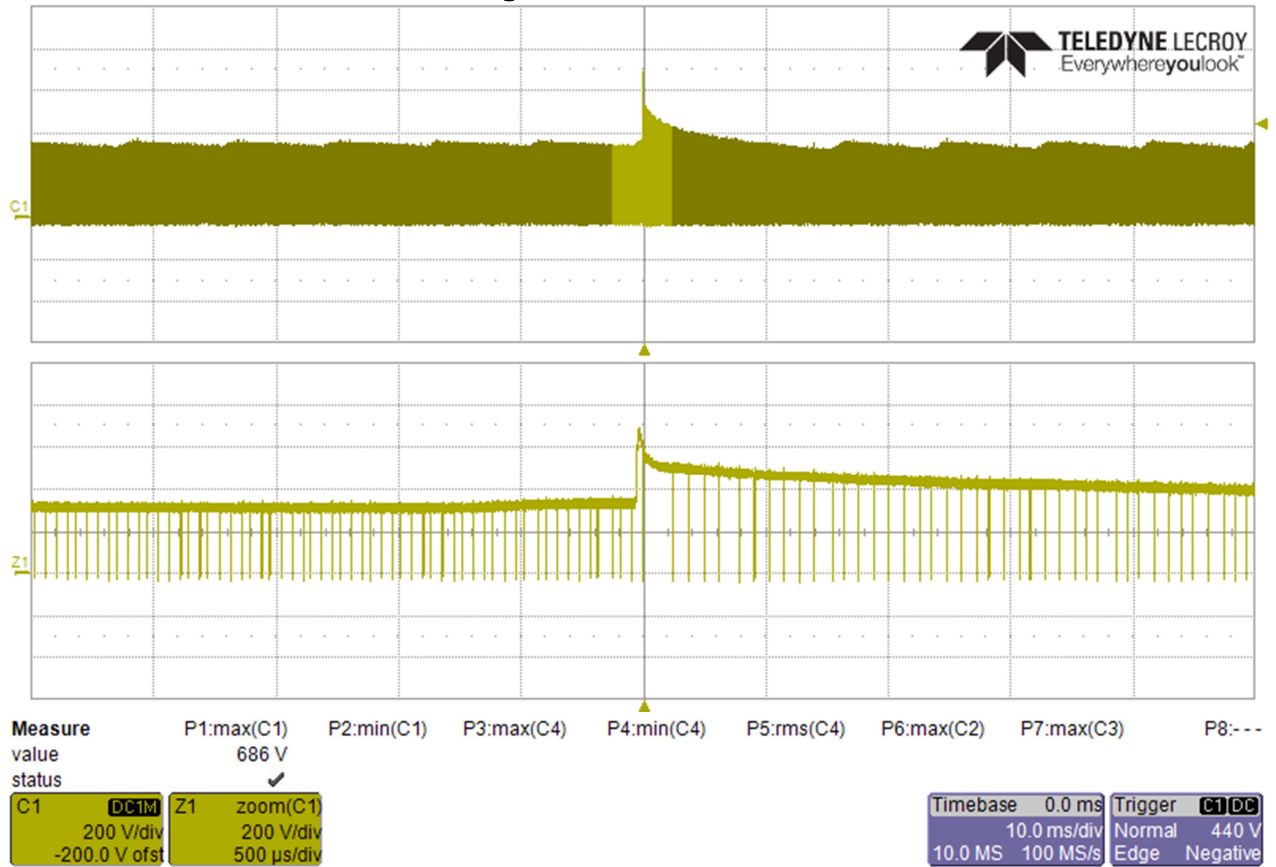

Figure 99 – Drain Voltage, 230 VAC, Full Load.



14 Audible Noise

14.1 *Test Set-up*

Sound Isolation Enclosure: Whisper Room™ SE 2000

Distance to microphone: 10 cm

Test settings: 0 mA to 550 mA load, 10 mA increments

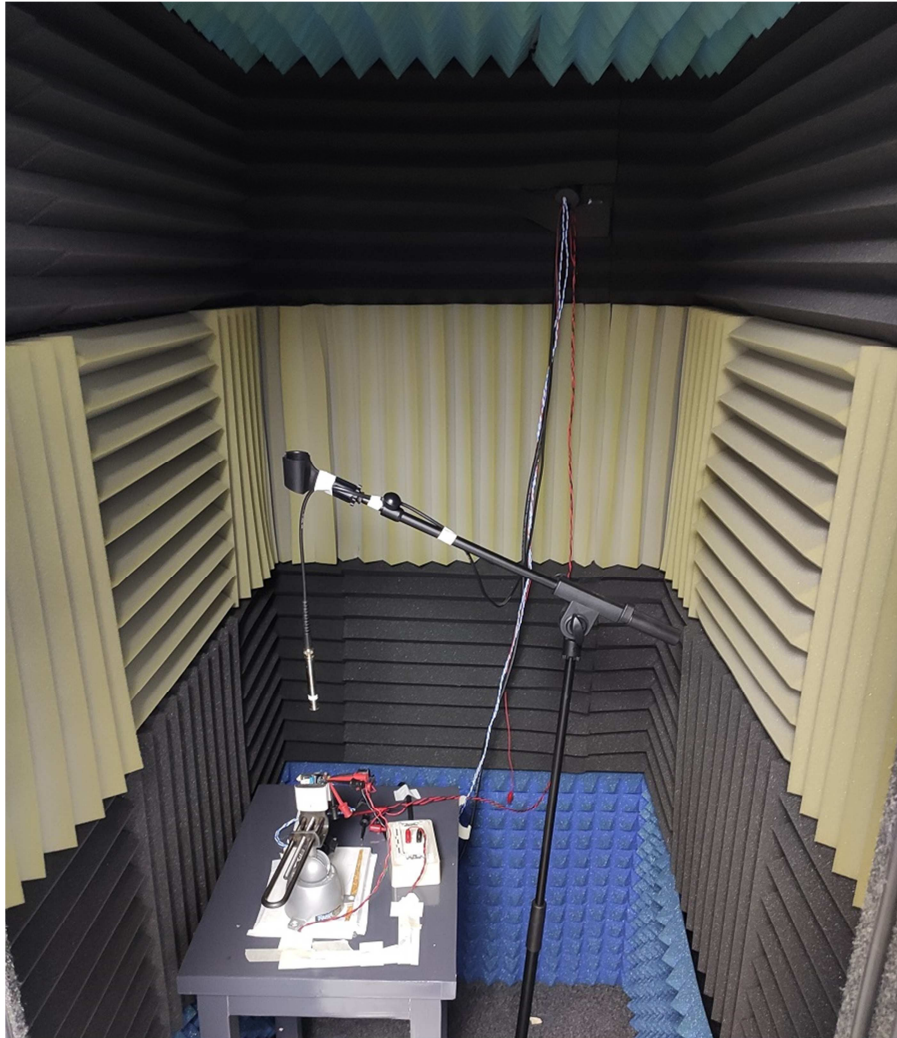

Figure 100 – Audible Noise Test Set-up.

14.2 **115 VAC**

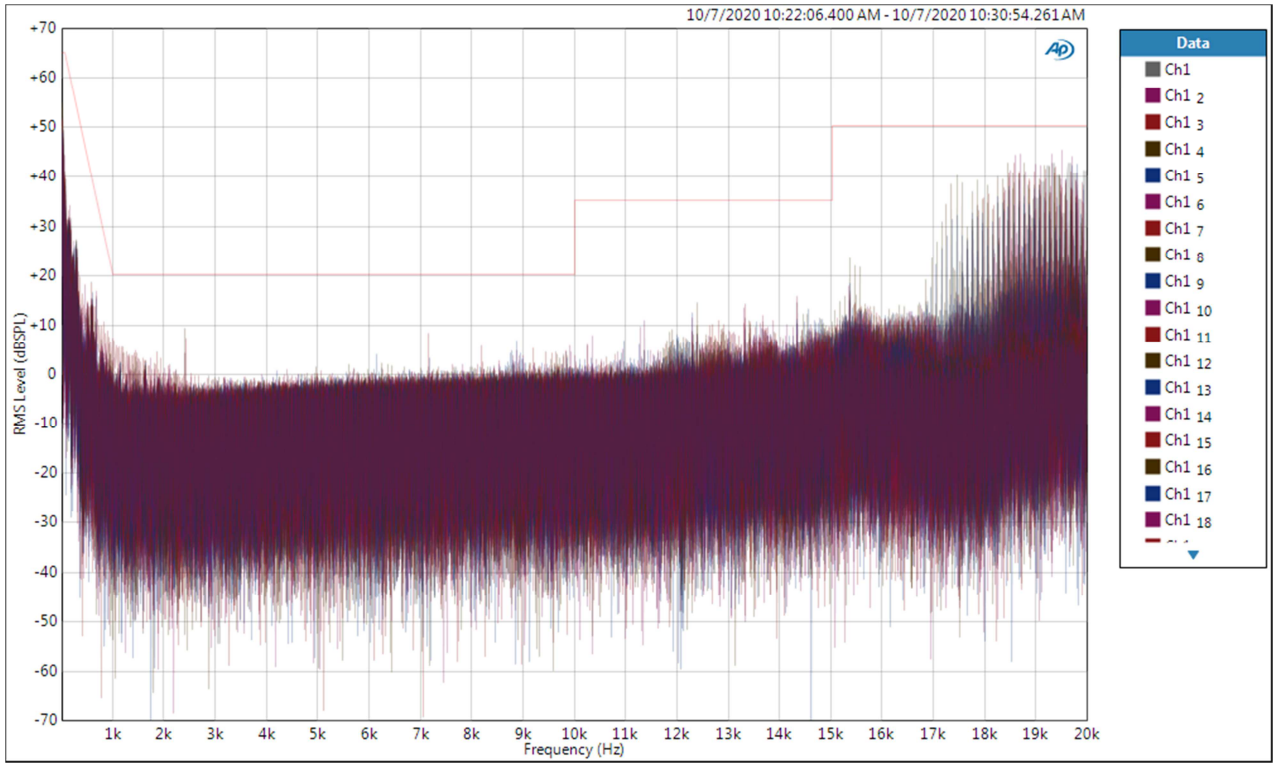

Figure 101 – Audible Noise at 115 VAC.



14.3 **230 VAC**

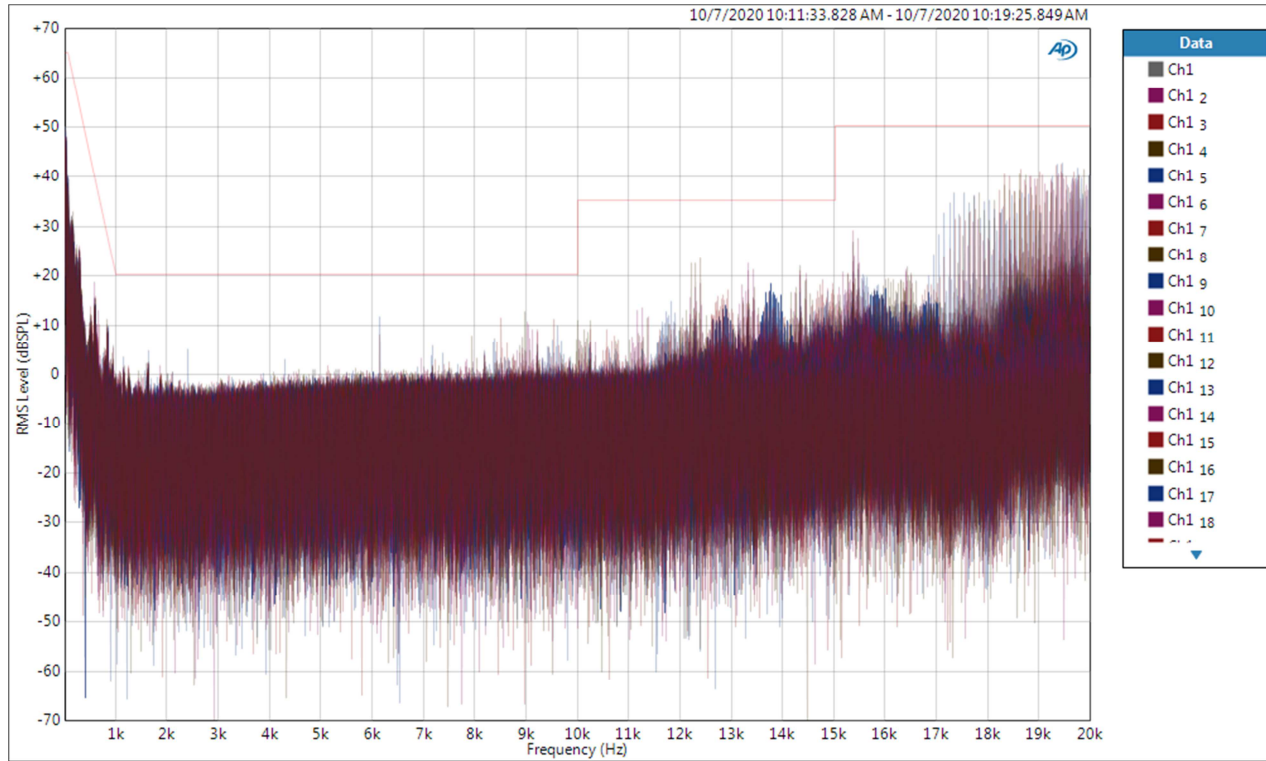

Figure 102 – Audible Noise at 230 VAC.

15 Revision History

Date	Author	Revision	Description & Changes	Reviewed
27-Oct-20	VRRA	1.0	Initial Release.	Apps & Mktg



For the latest updates, visit our website: www.power.com

Reference Designs are technical proposals concerning how to use Power Integrations' gate drivers in particular applications and/or with certain power modules. These proposals are "as is" and are not subject to any qualification process. The suitability, implementation and qualification are the sole responsibility of the end user. The statements, technical information and recommendations contained herein are believed to be accurate as of the date hereof. All parameters, numbers, values and other technical data included in the technical information were calculated and determined to our best knowledge in accordance with the relevant technical norms (if any). They may base on assumptions or operational conditions that do not necessarily apply in general. We exclude any representation or warranty, express or implied, in relation to the accuracy or completeness of the statements, technical information and recommendations contained herein. No responsibility is accepted for the accuracy or sufficiency of any of the statements, technical information, recommendations or opinions communicated and any liability for any direct, indirect or consequential loss or damage suffered by any person arising therefrom is expressly disclaimed.

Power Integrations reserves the right to make changes to its products at any time to improve reliability or manufacturability. Power Integrations does not assume any liability arising from the use of any device or circuit described herein. POWER INTEGRATIONS MAKES NO WARRANTY HEREIN AND SPECIFICALLY DISCLAIMS ALL WARRANTIES INCLUDING, WITHOUT LIMITATION, THE IMPLIED WARRANTIES OF MERCHANTABILITY, FITNESS FOR A PARTICULAR PURPOSE, AND NON-INFRINGEMENT OF THIRD PARTY RIGHTS.

Patent Information

The products and applications illustrated herein (including transformer construction and circuits' external to the products) may be covered by one or more U.S. and foreign patents, or potentially by pending U.S. and foreign patent applications assigned to Power Integrations. A complete list of Power Integrations' patents may be found at www.power.com. Power Integrations grants its customers a license under certain patent rights as set forth at <http://www.power.com/ip.htm>.

Power Integrations, the Power Integrations logo, CAPZero, ChiPhy, CHY, DPA-Switch, EcoSmart, E-Shield, eSIP, eSOP, HiperPLC, HiperPFS, HiperTFS, InnoSwitch, Innovation in Power Conversion, InSOP, LinkSwitch, LinkZero, LYTSwitch, SENZero, TinySwitch, TOPSwitch, PI, PI Expert, SCALE, SCALE-1, SCALE-2, SCALE-3 and SCALE-iDriver, are trademarks of Power Integrations, Inc. Other trademarks are property of their respective companies. ©2019, Power Integrations, Inc.

Power Integrations Worldwide Sales Support Locations**WORLD HEADQUARTERS**

5245 Hellyer Avenue
San Jose, CA 95138, USA.
Main: +1-408-414-9200
Customer Service:
Worldwide: +1-65-635-64480
Americas: +1-408-414-9621
e-mail: usasales@power.com

CHINA (SHANGHAI)

Rm 2410, Charity Plaza, No. 88,
North Caoxi Road,
Shanghai, PRC 200030
Phone: +86-21-6354-6323
e-mail: chinasales@power.com

CHINA (SHENZHEN)

17/F, Hivac Building, No. 2, Keji
Nan 8th Road, Nanshan District,
Shenzhen, China, 518057
Phone: +86-755-8672-8689
e-mail: chinasales@power.com

GERMANY (AC-DC/LED Sales)

Einsteinring 24
85609 Dornach/Aschheim
Germany
Tel: +49-89-5527-39100
e-mail: eurosales@power.com

GERMANY (Gate Driver Sales)

HellwegForum 1
59469 Ense
Germany
Tel: +49-2938-64-39990
e-mail: igbt-driver.sales@power.com

INDIA

#1, 14th Main Road
Vasanthanagar
Bangalore-560052
India
Phone: +91-80-4113-8020
e-mail: indiasales@power.com

ITALY

Via Milanese 20, 3rd. Fl.
20099 Sesto San Giovanni (MI) Italy
Phone: +39-024-550-8701
e-mail: eurosales@power.com

JAPAN

Yusen Shin-Yokohama 1-chome Bldg.
1-7-9, Shin-Yokohama, Kohoku-ku
Yokohama-shi,
Kanagawa 222-0033 Japan
Phone: +81-45-471-1021
e-mail: japansales@power.com

KOREA

RM 602, 6FL
Korea City Air Terminal B/D,
159-6
Samsung-Dong, Kangnam-Gu,
Seoul, 135-728 Korea
Phone: +82-2-2016-6610
e-mail: koreasales@power.com

SINGAPORE

51 Newton Road,
#19-01/05 Goldhill Plaza
Singapore, 308900
Phone: +65-6358-2160
e-mail: singaporesales@power.com

TAIWAN

5F, No. 318, Nei Hu Rd.,
Sec. 1
Nei Hu District
Taipei 11493, Taiwan R.O.C.
Phone: +886-2-2659-4570
e-mail: taiwansales@power.com

UK

Building 5, Suite 21
The Westbrook Centre
Milton Road
Cambridge
CB4 1YG
Phone: +44 (0) 7823-557484
e-mail: eurosales@power.com

